

A Field Calibration of the Sediment-Trapping Characteristics of the Helley-Smith Bedload Sampler

GEOLOGICAL SURVEY PROFESSIONAL PAPER 1139

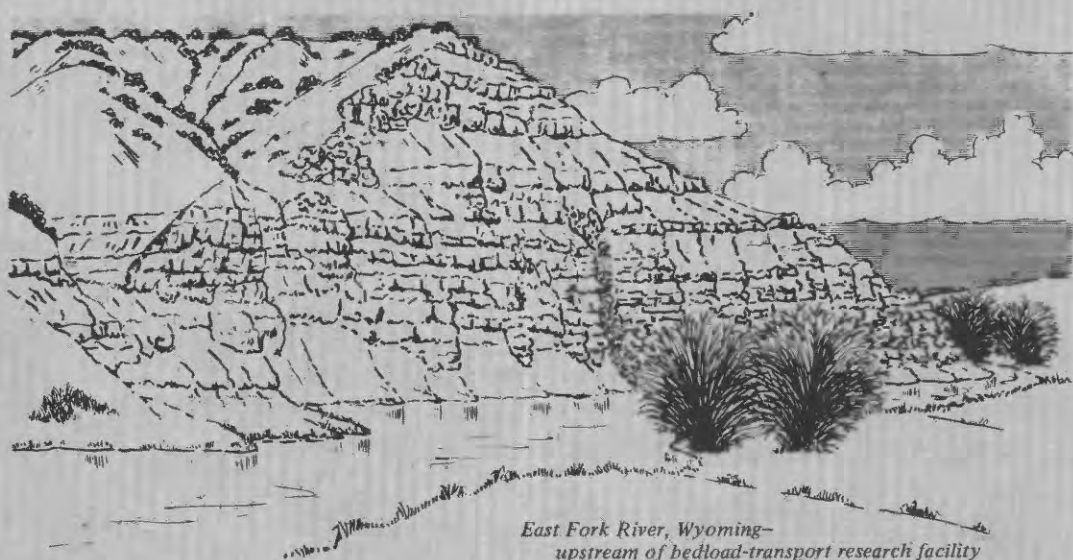

*East Fork River, Wyoming—
upstream of bedload-transport research facility*

A Field Calibration of the Sediment-Trapping Characteristics of the Helley-Smith Bedload Sampler

By WILLIAM W. EMMETT

GEOLOGICAL SURVEY PROFESSIONAL PAPER 1139

*Studies of bedload transport
in river channels*

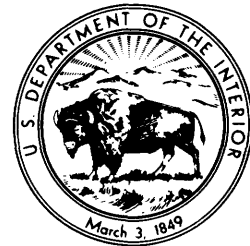

UNITED STATES DEPARTMENT OF THE INTERIOR

CECIL D. ANDRUS, *Secretary*

GEOLOGICAL SURVEY

H. William Menard, *Director*

Library of Congress Cataloging in Publication Data

Emmett, William W.

A field calibration of the sediment-trapping characteristics of the Helley-Smith bedload sampler.

(Geological Survey professional paper ; 1139)

Bibliography: P. 29-30.

Supt. of Docs. no.: I 19.16:1139

1. Bedload—Measurement. 2. Hydrology—Instruments. I. Title.

II. Title: Helley-Smith bedload sampler. III. Series: United

States. Geological Survey. Professional paper ; 1139.

GB850.E45

551.3'03'028

80-607050

For sale by the Superintendent of Documents, U.S. Government Printing Office
Washington, D.C. 20402

CONTENTS

	Page
Abstract	1
Introduction	1
Bedload	1
Helley-Smith bedload sampler	2
Description of field-test facility	3
East Fork River	3
Conveyor-belt bedload trap	4
Sampling techniques with Helley-Smith bedload sampler	8
Results of field-calibration tests	9
Bedload-transport rates by individual particle-size categories, basic data	10
Comparison of Helley-Smith results to conveyor-belt results, basic data	14
Modifications to the basic data	19
Summary and recommendations	27
Acknowledgments	27
References cited	27

ILLUSTRATIONS

FIGURE		Page
1.	Sketch of the Helley-Smith bedload sampler	2
2.	Plan and side-elevation drawings of 7.62-cm Helley-Smith bedload sampler	2
3.	Graph showing vertical-velocity profiles upstream of sampler, and in sampler orifice of 7.62-cm Helley-Smith bedload sampler	3
4.	Map of East Fork River drainage area upstream of the project site	3
5.	Planimetric map of East Fork River in vicinity of bedload trap, showing median diameter of bed material at sections along river	5
6.	Cross section of the East Fork River at the bedload trap	5
7.	Photographs of the East Fork River and conveyor-belt bedload sampler	6
8.	Graph of hydraulic-geometry relations for the East Fork River at the bedload trap	7
9.	Photographs showing use of the Helley-Smith sampler at the bedload trap	9
10-18.	Graphs showing relation of bedload-transport rate in individual-size category as function of total bedload-transport rate for Helley-Smith sampler and conveyor-belt sampler:	
10.	0.06-0.12 mm size class	11
11.	0.12-0.25 mm size class	11
12.	0.25-0.50 mm size class	12
13.	0.50-1.00 mm size class	12
14.	1.00-2.00 mm size class	13
15.	2.00-4.00 mm size class	13
16.	4.00-8.00 mm size class	14
17.	8.00-16.0 mm size class	14
18.	16.0-32.0 mm size class	15
19-27.	Graphs showing comparison of bedload-transport rate by individual particle-size category for Helley-Smith sampler and conveyor-belt sampler:	
19.	0.06-0.12 mm size class	16
20.	0.12-0.25 mm size class	16
21.	0.25-0.50 mm size class	16
22.	0.50-1.00 mm size class	16
23.	1.00-2.00 mm size class	17
24.	2.00-4.00 mm size class	17
25.	4.00-8.00 mm size class	17
26.	8.00-16.0 mm size class	17
27.	16.0-32.0 mm size class	18

	Page
FIGURES 28-39. Graphs showing comparison of total bedload-transport rate:	
28. Helley-Smith sampler and conveyor-belt sampler; conveyor-belt sampler designated as independent variable	20
29. Helley-Smith sampler and conveyor-belt sampler; Helley-Smith sampler designated as independent variable	20
30. Helley-Smith sampler and conveyor-belt sampler corrected to condition of stream-wide slot; conveyor-belt sampler designated as independent variable	21
31. Helley-Smith sampler and conveyor-belt sampler corrected to condition of stream-wide slot; Helley-Smith sampler designated as independent variable	21
32. Helley-Smith sampler corrected for stage difference and conveyor-belt sampler corrected for condition of stream-wide slot	21
33. Helley-Smith sampler corrected for stage difference and conveyor-belt sampler corrected for condition of stream-wide slot; relation corrected for variance of the independent variable in the least-squares regression	22
34. Sediment particles larger than 0.25 mm; Helley-Smith sampler and conveyor-belt sampler corrected for condition of stream-wide slot	22
35. Sediment particles larger than 0.50 mm; Helley-Smith sampler and conveyor-belt sampler corrected for condition of stream-wide slot	23
36. Sediment particles larger than 0.50 mm; Helley-Smith sampler and conveyor-belt sampler corrected for condition of stream-wide slot; relation corrected for variance of the independent variable in the least-squares regression	23
37. Sediment particles larger than 0.25 mm; Helley-Smith sampler corrected for stage difference and conveyor-belt sampler corrected for condition of stream-wide slot	23
38. Sediment particles larger than 0.50 mm; Helley-Smith sampler corrected for stage difference and conveyor-belt sampler corrected for condition of stream-wide slot	24
39. Sediment particles larger than 0.50 mm; Helley-Smith sampler corrected for stage difference and conveyor-belt sampler corrected for condition of stream-wide slot; relation corrected for variance of the independent variable in the least-squares regression	24
40-48. Graphs showing comparison of bedload-transport rate by individual particle-size category, Helley-Smith sampler and conveyor-belt sampler corrected for condition of stream-wide slot:	
40. 0.06-0.12 mm size class	25
41. 0.12-0.25 mm size class	25
42. 0.25-0.50 mm size class	25
43. 0.50-1.00 mm size class	25
44. 1.00-2.00 mm size class	26
45. 2.00-4.00 mm size class	26
46. 4.00-8.00 mm size class	26
47. 8.00-16.0 mm size class	26
48. 16.0-32.0 mm size class	27

TABLES

	Page
TABLE 1. Size distribution of composited bed material, East Fork River, Wyoming, at bedload-transport research project	7
2. Size distribution of transport-weighted composite bedload (1976 conveyor belt), East Fork River, Wyoming, at bedload-transport research project	7
3. Comparison of bed material and bedload particle sizes	7
4. Summary data of river hydraulics and bedload transport, conveyor-belt sampler	30
5. Particle-size distribution of bedload sediment, conveyor-belt sampler	32
6. Summary data of river hydraulics and bedload transport, Helley-Smith sampler	36
7. Particle-size distribution of bedload sediment, Helley-Smith sampler	38
8. Summary of statistical data: log-transformed linear regression of transport rate by particle-size class versus total transport rate, conveyor-belt sampler	41

	Page
TABLE 9. Summary of statistical data: log-transformed linear regression of transport rate by particle-size class versus total transport rate, Helley-Smith sampler	41
10. Listing of comparable data sets used in direct comparison of results from conveyor-belt sampler with results from Helley-Smith sampler	41
11. Summary of statistical data: log-transformed linear regression of transport rate, Helley-Smith sampler versus conveyor-belt sampler (basic data)	43
12. Summary of statistical data: log-transformed linear regression of transport rate, Helley-Smith sampler versus conveyor-belt sampler (comparison of various modifications to the basic data)	43
13. Summary of statistical data: log-transformed linear regression of transport rate, Helley-Smith sampler versus conveyor-belt sampler (conveyor-belt data corrected for conditions of stream-wide slot)	44

SYMBOLS

<i>A, A'</i>	Coefficient in regression equation.	<i>r</i>	Correlation coefficient.
<i>B, B'</i>	Exponent in regression equation.	<i>SD</i>	Standard deviation.
<i>CB</i>	Reference to conveyor-belt sampler.	<i>SE</i>	Standard error.
<i>d</i>	Sediment-particle size, in millimeters.	<i>V</i>	Mean velocity of effective discharge, in meters per second.
<i>D</i>	Mean depth of effective discharge, in meters.	<i>W</i>	Effective width of channel, = 14.6 m.
<i>HS</i>	Reference to Helley-Smith sampler.	<i>X</i>	Independent variable.
<i>j_b</i>	Unit transport rate of sediment in dry weight per second, in kilograms per second per meter.	<i>Y</i>	Dependent variable.
<i>P</i>	Probability distribution.	σ_i^2	Variance of the error in the independent variable.
<i>Q</i>	Complete river discharge, in cubic meters per second.	σ_x^2	Variance of independent variable.
<i>Q'</i>	Discharge over 14.6-m width of bedload trap; includes all flow over active width of the streambed, in cubic meters per second.	Σ	Summation.
		-	(superscript) reference to mean value of parameter.

A FIELD CALIBRATION OF THE SEDIMENT-TRAPPING CHARACTERISTICS OF THE HELLEY-SMITH BEDLOAD SAMPLER

BY WILLIAM W. EMMETT

ABSTRACT

For sediment particle sizes between 0.50 and 16 millimeters, the Helley-Smith bedload sampler has a near-perfect sediment-trapping efficiency. For particle sizes smaller than 0.50 millimeters, the Helley-Smith sampler has a high bedload sediment-trapping efficiency because part of the sediment retained by the sampler has been transported in suspension and cannot be quantified separately from the bedload. For particle sizes larger than about 16 millimeters, the Helley-Smith sampler has a low sediment-trapping efficiency, but this may be related to the paucity of coarse particles in transport in the calibration tests, rather than a reflection of an actual low trap efficiency for large-size particles.

INTRODUCTION

Schoklitsch (1950), in reference to bedload transport, stated "there is not too much known about it." His statement was not without reason; the problems associated with measurement of bedload transport in alluvial channels are significant. Hubbell (1964) has described many of the problems encountered with measurement of bedload and also provided a current (at that time) state-of-the-art report on apparatus and techniques for measuring bedload. The reader is referred to the discussion by Hubbell for an overview of various bedload-sampling devices and the merits and shortcomings of each device.

Bedload samplers of the direct-measuring type are simplest and most widely used. A direct-measuring bedload sampler intercepts sediment that is in transport over a small incremental width of streambed and accumulates the sediment in a chamber within the sampler. The sampling efficiency of a bedload sampler is defined (Hubbell, 1964) as the ratio of the weight of bedload collected during a sampling time to the weight of bedload that would have passed through the sampler width in the same time had the sampler not been there. Ideally, the ratio is 1.0, and the weight of every particle-size fraction in the collected sample is in the same proportion as in the true bedload discharge.

This report presents information on a field calibration of the sediment-trapping efficiency of the Helley-Smith bedload sampler, developed since the Hubbell report. Because the Helley-Smith bedload sampler

presently is in widespread use (probably in excess of over 200 samplers worldwide), the data of this report are of particular significance. However, test conditions for field calibration during this study were limited, and thus results are certain not to be applicable to all situations in which the Helley-Smith bedload sampler is being used or being proposed for use.

BEDLOAD

Bedload is that sediment carried down a river by rolling and saltation on or near the streambed. Though bedload may best be defined as that part of the sediment load supported by frequent solid contact with the unmoving bed, in practice it is the sediment moving on or near the streambed rather than in the bulk of the flowing water.

In the sediment-transport process, individual bed-material particles are lifted from the streambed and set into motion. If the motion includes frequent contact of a particle with the streambed, the particle constitutes part of the bedload. If the motion includes no contact with the streambed, the particle is literally a part of the suspended load, regardless of how close to the streambed the motion occurs and whether or not the particle is capable of being sampled by existing suspended-sediment sampling equipment. Depending on the hydraulics of flow in various reaches of a channel, particles may alternate between being a part of the bedload or a part of the suspended load. Likewise at a given cross section of channel, particles that are a part of the bedload at one stage may be a part of the suspended load at another stage. Any particle in motion may come to rest, and for bedload, the downstream progress is likely to be a succession of movements and rest periods. Particles at rest are part of the bed material. Obviously, there is an intimate relation between the bed material, bedload, and suspended load.

Owing to the somewhat nebulous definition of bedload, it becomes an exceedingly difficult task to build measuring equipment which samples only bedload. Any device which rests on the streambed is perilously close to sampling bed material, and any device which

protrudes upwards from the streambed, or by necessity is raised or lowered through the flow, may sample some part of the suspended load.

This paper utilizes the practical definition of bedload; that is, bedload is the sediment moving on or near the streambed. A sampler used to measure the transport rate of bedload, by the practical definition, is designated a bedload sampler. This designation does not preempt the fact that some amount of suspended load also may be measured. This possibility and its implications are discussed in a later section of this report.

HELLEY-SMITH BEDLOAD SAMPLER

Helley and Smith (1971) introduced a pressure-difference bedload sampler that is a structurally modified version of the Arnhem sampler (Hubbell, 1964). The Helley-Smith bedload sampler has an expanding nozzle, sample bag, and frame (fig. 1). The sampler was designed to be used in flows with mean velocities to 3 m/s and sediment sizes from 2 to 10 mm. The sampler has a square 7.62-cm entrance nozzle and a 46 cm-long sample bag constructed of 0.2-mm mesh polyester, though more recently it has become standard practice to use a sample bag of 0.25-mm mesh polyester. The standard sample bag has a surface area of approximately 1,900 cm². Details of the sampler nozzle and frame assembly are shown in figure 2.

The original design included a brass nozzle, aluminum-tubing frame weighted with poured molten lead to a total weight of 30 kg, aluminum tail fins, and bolted construction. More recent versions of the sampler have stainless-steel nozzles for greater durability, steel-plate tail fins, solid-steel round-stock bar frame selected to maintain a 30-kg total weight, and all-welded construction. The sample bag attaches to the

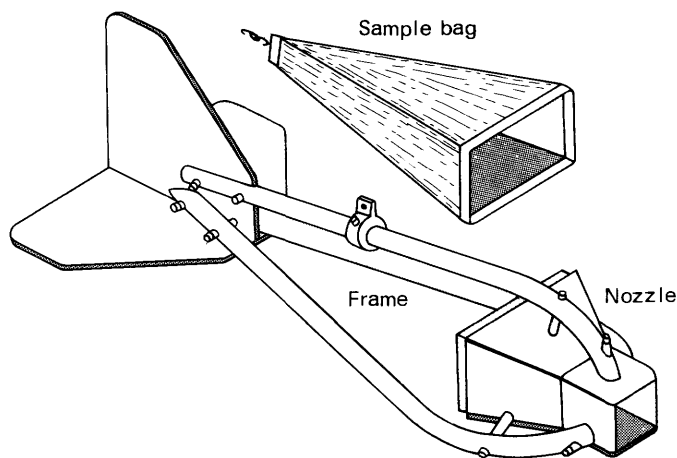

FIGURE 1.—Sketch of the Helley-Smith bedload sampler.

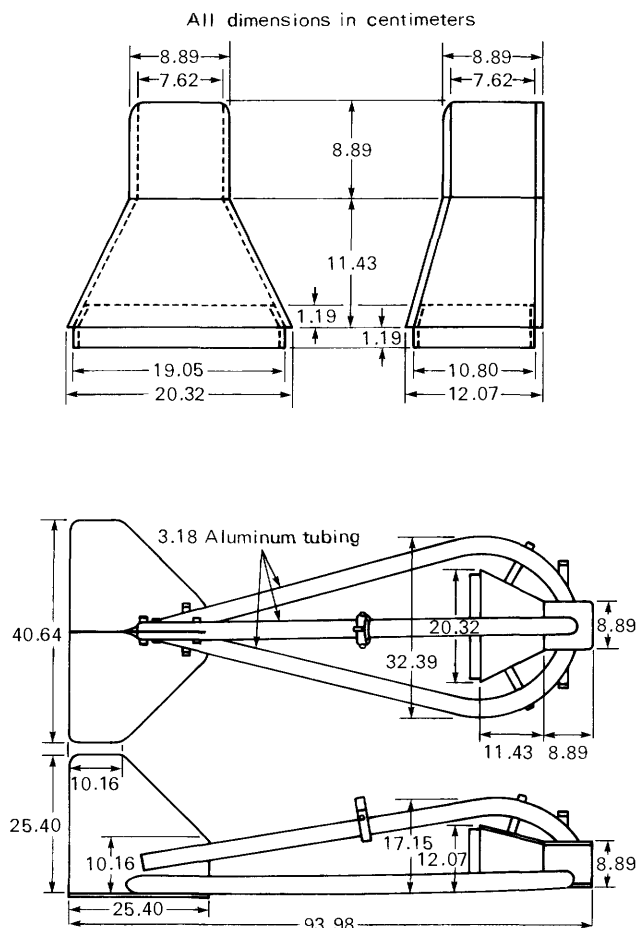

FIGURE 2.—Plan and side elevation drawings of 7.62-cm Helley-Smith bedload sampler nozzle (above) and sampler (below).

rear of the nozzle with a rubber "O" ring. A sliding bracket on the top frame member allows for cable-suspended lowering and raising of the sampler. Position of the bracket along the frame controls the sampler attitude; normal attitude is a slightly tail-heavy position (about 15-degree angle).

Since this original design, several structurally different versions of the sampler have been built to adapt the sampler to various field uses. One version, developed by the author, has been scaled up from the 7.62-cm sampler. The orifice is twice scale (15.24 cm), and the frame is one and one-half scale. The larger frame assembly allows for greater weighting; total weight of the larger sampler has generally been either 45 kg or 75 kg, but one sampler constructed for use on the Amazon River weighs 250 kg. The large-nozzle sampler is generally used to sample larger sediment sizes, and the heavier samplers become necessary as deeper and swifter rivers are sampled.

Perhaps the most extensively used version of the sampler is the 7.62-cm nozzle adapted to a wading rod,

rather than having a frame and tail-fin assembly. To minimize weight and to facilitate use of this model, the nozzle is generally of cast aluminum and equipped with a sectionalized tubular aluminum wading rod.

A laboratory hydraulic calibration of the Helley-Smith bedload sampler has been conducted (Druffel and others, 1976). Hydraulic efficiency of a bedload sampler has been defined (Hubbell, 1964) as the ratio of the mean velocity of water discharge through the sampler to the mean velocity of the water discharge which would have occurred through the area occupied by the opening in the sampler nozzle had the sampler not been there. In the laboratory study, velocity profiles were measured in the sampler nozzle and at various locations upstream from the sampler. Typical velocity profiles are illustrated in figure 3. The results of this study showed the hydraulic efficiency of the 7.62-cm and the 15.24-cm Helley-Smith bedload sampler is approximately 1.54. This value of hydraulic efficiency was found to be constant for the range of flow conditions in the experiments, a range applicable to many natural streamflow conditions.

The study, along with other observations by the author, indicates the sample bag can be filled to 40 percent capacity with sediment larger than the mesh size (0.2–0.25 mm) of the bag without reduction in hydraulic efficiency. However, sediment with diameters close to the mesh size of the sample bag both plugs the sample bag and escapes through the mesh, causing an unpredictable decrease in hydraulic efficiency and loss of the sample.

Data on the hydraulic characteristics of the sampler provide qualitative information about probable performance, but such data cannot be used directly to

evaluate the sediment-trap efficiency of the unit. Controlled experiments are still needed to define sediment-trap efficiency; this report describes the results of one such field calibration of the sampler.

DESCRIPTION OF FIELD-TEST FACILITY

An open slot in the streambed of the East Fork River, Wyoming, continually excavated of trapped debris by a conveyor belt, provided a bedload trap and direct quantitative measurement of bedload-transport rates for comparison with bedload-transport rates measured with the Helley-Smith bedload sampler. The following sections describe the test stream, conveyor-belt bedload trap, and procedures followed in using the Helley-Smith bedload sampler.

EAST FORK RIVER

The East Fork River heads in the Wind River Range of Wyoming west of the Continental Divide and east and south of Mt. Bonneville (fig. 4). From a series of small alpine lakes and an altitude of approximately

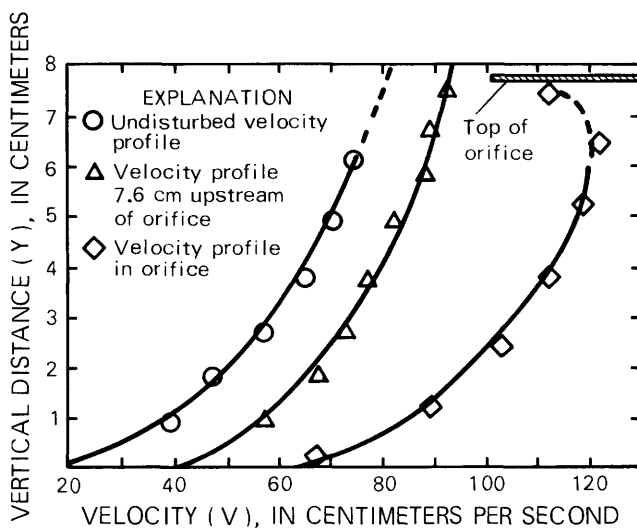

FIGURE 3.—Vertical-velocity profiles upstream of sampler and in sampler orifice of 7.62-cm Helley-Smith bedload sampler.

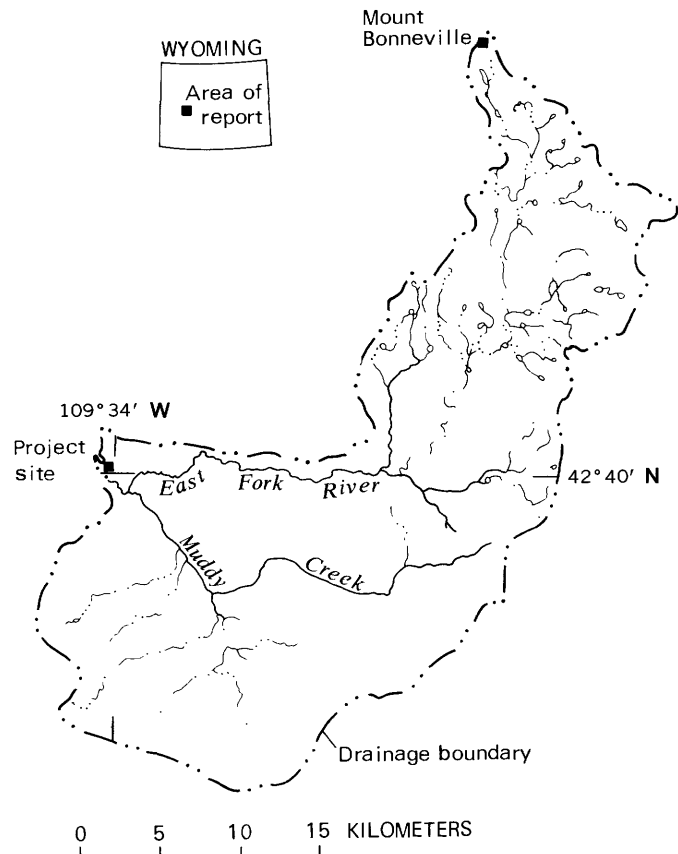

FIGURE 4.—Map of East Fork River drainage area upstream of the project site.

3,400 m, the East Fork River descends about 1,250 m in 50 river km to the project site described in this report. Downstream from the study reach, it continues another 50 km to its confluence with the New Fork River, tributary to the Green River.

The project site is at lat 42°40'23" N., long 109°34'16"W. The drainage area of the East Fork River at the project site is 466 km². About half of this basin area lies within the Wind River Mountains and is underlain by granitic and metamorphic rocks, mostly of Precambrian age; the other half of the basin area is provided by a major tributary, Muddy Creek, that enters the East Fork River about 5 km upstream of the project and drains an upland of rolling hills underlain by lower Tertiary sandstone and shale of the Wasatch Formation. Much of the sand portion of the sediment load for the East Fork River comes from the Muddy Creek basin, but most of the water during high flow comes from melting snow of the mountain area. The high-flow season is generally late May to mid-June, and little bedload movement occurs at other times in the year.

In the vicinity of the project, the East Fork River meanders in a flood plain averaging 120 m in width, which, in turn, is confined within a glacial outwash terrace of sand and gravel, the tread or surface of which is some 5 m above the flood plain. This terrace and outcrops of the Wasatch are sources of fresh sand and gravel debris wherever the river impinges laterally against them.

The level of the flood plain corresponds with the bankfull stage of the river, at which the water has an average depth of about 1.2 m. The bankfull discharge is about 20 m³/s, which, in the annual flood series, has a recurrence interval of about 1.5 years. The water-surface slope in the vicinity of the project area is 0.0007, averaged over 1.5 km of river length.

Composition of the streambed of the East Fork River at the project site is predominantly sand, but in the 5-km reach of river from Muddy Creek to the project, gravel bars are spaced at regular intervals of about five to seven channel widths. Eight bed-material samples were collected at each of 29 sections along approximately a 200-m reach upstream and downstream of the bedload trap. Data of the composite size distribution of the 232 samples (about 200 kg) are included in table 1 and indicate a median bed-material particle size of 1.25 mm. The median bed-material particle sizes at each of the 29 sections are shown on the planimetric map of figure 5. The occurrence and location of gravel bars is apparent, as median particle sizes vary from 0.6 to 25 mm and indicate a large range of particle sizes available for transport. However, the majority of median particle-size data indicate an overwhelming abundance of medium to coarse sand available for transport.

Only limited information is available describing bedforms and their characteristics. At low flows when bedload is negligible, ripples exist over the sandy portions of the streambed. Isolated sediment particles may be in motion, but generally the ripples are stationary. From intermediate flows to the highest discharges observed, the bed is either flat or has long, low dunes and is fairly resistant to local scour around a foreign object placed on the bed. The better defined bedforms, as recorded on sonar tracings, indicate an amplitude of about 10 cm, a wave length of about 10 m, and a period of about 30 minutes. These characteristics of the dunes are substantiated by cyclic trends in measured bedload-transport rates. However, the measured bedload-transport rates cannot be used to quantitatively describe bedforms, because dune fronts traveled diagonally to the flow, whereas bedload measurements were taken orthogonally to the flow and integrated the passage of bedforms over time.

CONVEYOR-BELT BEDLOAD TRAP

Across the East Fork River, a concrete trough was constructed in the bed, orthogonal to the flow direction, that would constitute an open slot into which would fall any sediment moving near or on the streambed. The trough is 0.4 m wide and 0.6 m deep; the level of the lip or top surface corresponds to the natural bed, lower in elevation at the thalweg than near the banks. Figure 6 is a cross section at the bedload trap; although at the trap the entire wetted perimeter is bounded by concrete construction, only at the definite angles at changes in boundary projections is the cross section different than the preconstruction cross section.

Along the bottom of the concrete trough passes an endless belt of rubber, 0.3 m wide; it is threaded around some drive and guidance cylinders, then returns overhead, where it is supported by a suspension bridge across the river. Thus, sediment falling into the open slot drops on the moving belt, then is carried laterally to a sump constructed in the riverbank, where it is scraped off the belt. From the sump, sediment is excavated by a series of perforated buckets on an endless belt. The buckets lift the sediment to an elevation 3 m above the riverbank and dump the load into a weighing hopper. When the hopper is periodically evacuated by opening a bottom door, accumulated sediment falls on a horizontal endless belt that carries it in a downstream direction 12 m and dumps the load on a transverse endless belt, which, in turn, carries the debris toward the river and dumps it into the flowing water, to be carried downstream in a normal manner. In this way, trapped sediment is collected, weighed continuously, and returned to the river. Figure 7 provides some general views of the river and the bedload trap.

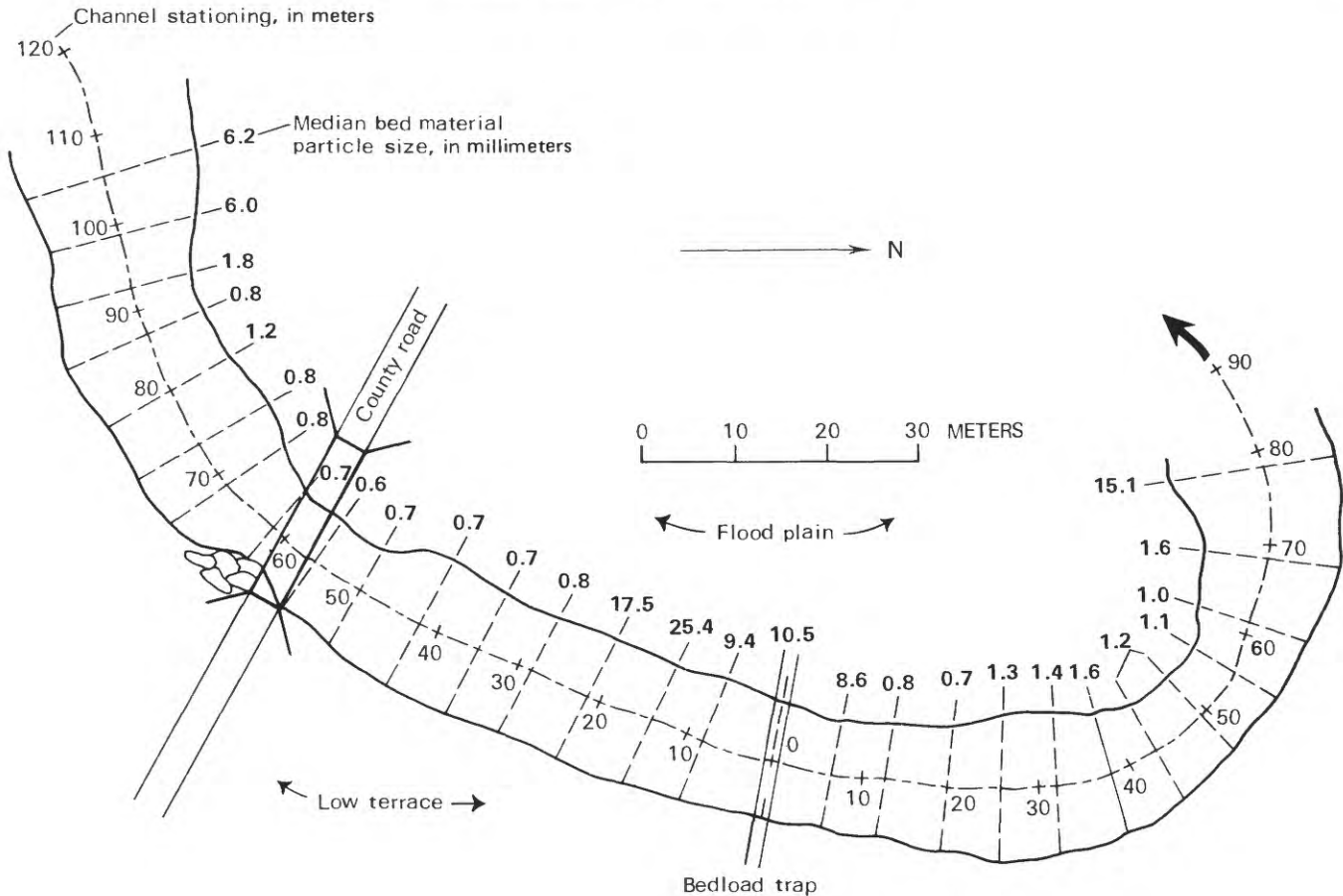

FIGURE 5.—Map of East Fork River in vicinity of bedload trap; data show median diameter of bed material at sections along river.

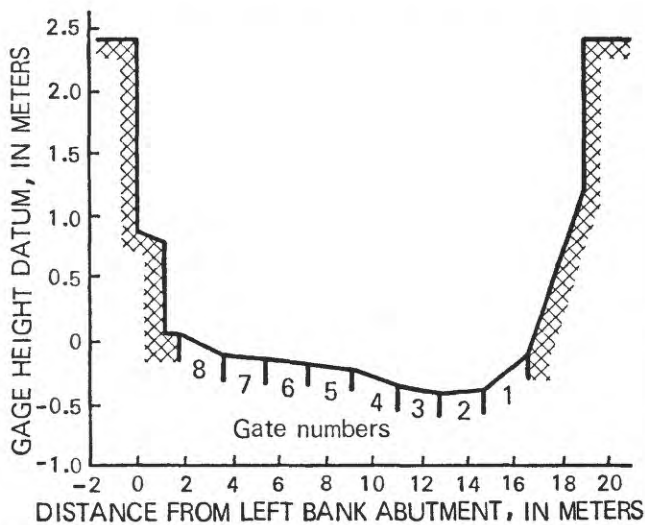

FIGURE 6.—Cross section of the East Fork River at the bedload trap.

The concrete slot across the riverbed may be closed by a series of eight gates, each 1.83 m in length. The gated length of the slot is thus 14.6 m, constituting the full width of the bed active in bedload transport. The gates are actuated hydraulically and may be opened or

closed individually. When the gates are open, the open slot or trap is 0.25 m wide. At low and moderate discharges, all gates are open so that the load accumulated in the weighing hopper represents the total for the river. At high discharges, gates are opened individually, and the transport rate for the whole river is computed by adding the rates recorded in the eight gates individually opened. The hopper collecting the debris stands on a large scale that may be read visually. The belt-and-bucket-transport system can accommodate a load received at a rate as great as 100 kg/min. The weight of the trapped load is recorded each minute as it accumulates in the hopper, so the weights represent a wet sample. Numerous comparisons of the weight of samples when wet and after drying give a consistent ratio of dry/wet weight of 0.85. Mean transport rates are determined by averaging the 1-minute recordings over a sampling duration of 30 minutes to several hours.

Samples of the trapped sediment for size analysis are scooped from the endless belt as the weighing hopper is periodically emptied. Samples were collected every time the hopper was emptied; each sample retained weighed about 2 kg. These samples were taken to the laboratory where they were dried, sieved, and weighed



FIGURE 7.—Conveyor-belt bedload sampler, East Fork River, Wyoming. *A*, View across river showing suspension bridge and drive mechanism of conveyor-belt bedload sampler; flow is relatively low. *B*, View downstream at suspension bridge; flow is relatively

by size fractions. For small samples (single emptying of the hopper), the entire sample was used in the sieve analysis. For large samples (multiple emptying of the hopper), the entire sample was sieved for gravel-size sediment (>2.0 mm) and the remainder split to about 1 kg for sieving of the material smaller than 2.0 mm. In all instances, the sample retained was large enough to be representative of all sizes of material collected, and the sieving procedure maintained this accuracy throughout the analysis. For comparison with the bed-material size data in table 1, table 2 lists a transport-weighted particle-size distribution for the whole of bedload sampled in 1976. The median particle size of bedload is 1.13 mm, compared to 1.25 mm for bed material.

Although the median particle size of bedload and bed material is nearly the same, the bed material consists

high. *C*, Bedload trap on streambed is visible below suspension bridge; gates are in closed position. *D*, Vertical-lift assembly, weighing hopper, and conveyor belt for return of sampled sediment to stream.

of some larger particles that are rarely moved. For bedload and bed material, table 3 lists particle size at given particle-size categories (given percentage, by weight, finer than values). Table 3 clearly indicates that some bed-material particle sizes are seldom involved in the sediment-transport process.

Discharge measurements by current meter are made nearly every day during the sampling season from the suspension bridge at the project site. At low flow, all discharge, Q , is within the 14.6-m width of the gated slot; at bankfull ($Q \approx 20$ m³/s) discharge, the water spreads over the full 19-m width of channel, but only 5 percent of this discharge is in the near-bank zones beyond the 14.6-m wide bedload trap; at maximum discharge (45 m³/s), about 8 percent of the discharge is beyond the ends of the bedload trap. Though overbank flow onto the flood plain occurs in other reaches of the

TABLE 1.—Size distribution of composited bed material, East Fork River, Wyoming, at bedload-transport research project

Sieve diameter (mm)	Percentage, by weight, retained on sieve	Percentage, by weight, finer than sieve
Pan	0.3	0.0
0.062	.1	.3
.088	.4	.4
.125	1.0	.8
.177	2.4	1.8
.250	6.6	4.2
.350	12.0	10.8
.500	13.5	22.8
.710	9.1	36.2
1.00	7.4	45.3
1.40	6.1	52.7
2.00	4.7	58.8
2.80	4.3	63.5
4.00	3.6	67.8
5.60	3.6	71.4
8.00	3.6	75.0
11.3	4.3	78.5
16.0	4.1	82.8
22.6	5.1	86.9
32.0	5.2	92.0
45.0	2.8	97.2
64.0	.0	100.0

TABLE 2.—Size distribution of transport-weighted composite bedload (1976 conveyor belt), East Fork River, Wyoming, at bedload-transport research project

Sieve diameter (mm)	Percentage, by weight, retained on sieve	Percentage, by weight, finer than sieve
Pan	0.3	0.0
0.062	.1	.3
.088	.2	.4
.125	.4	.6
.177	1.0	1.0
.250	5.3	1.9
.350	11.8	7.2
.500	15.1	19.0
.710	11.8	34.1
1.00	11.9	45.9
1.40	12.0	57.8
2.00	9.9	69.9
2.80	7.4	79.8
4.00	5.5	87.2
5.60	3.4	92.7
8.00	1.8	96.1
11.3	1.0	97.9
16.0	.5	98.9
22.6	.4	99.4
32.0	.2	99.8
45.0	.0	100.0

TABLE 3.—Comparison of bed material and bedload particle sizes

Particle-size category ($d_{(percentage\ finer\ than)}$)	Particle size (mm)	
	Bed material	Bedload
d_5	0.27	0.32
d_{16}	.42	.47
d_{25}	.53	.58
d_{35}	.69	.73
d_{50}	1.25	1.13
d_{65}	3.20	1.73
d_{75}	8.00	2.37
d_{84}	17.6	3.42
d_{95}	37.6	7.01

river, at the project site a high natural bank on the right side and a short embankment on the left prevent any overbank flow. Essentially, all bedload is accounted for, and all the flow passes through the 19-m width of channel at the measuring section.

The hydraulic-geometry relations for the East Fork River at the bedload trap are shown in figure 8. In reality, the concrete trough and abutments of the bedload trap force small "kinks" in the hydraulic-geometry relations; the relations shown in figure 8 have been smoothed and reflect the hydraulic characteristics of the river if the bedload trap were not installed. For interpretative studies of bedload transport, the hydraulic conditions above the 14.6-m width of bedload trap are more significant than the whole-channel hydraulic conditions. These hydraulic conditions will be termed "effective hydraulics," and it is the effective hydraulic parameters that are listed in subsequent tabulations of data in this report. The reader may obtain corresponding stream-wide conditions by reference to figure 8.

The bedload trap was installed in fall and spring, 1972-73. Robert M. Myrick was project engineer for construction of the trap and is due much of the credit for subsequent successful operation of the installation. Data collection began in the spring of 1973 and has continued during spring months since then. The data-collection program for the conveyor-belt bedload sampling was initially under the direction of Luna B. Leopold but gradually has drifted toward co-direction by Leopold and the writer. Basic data for the bedload

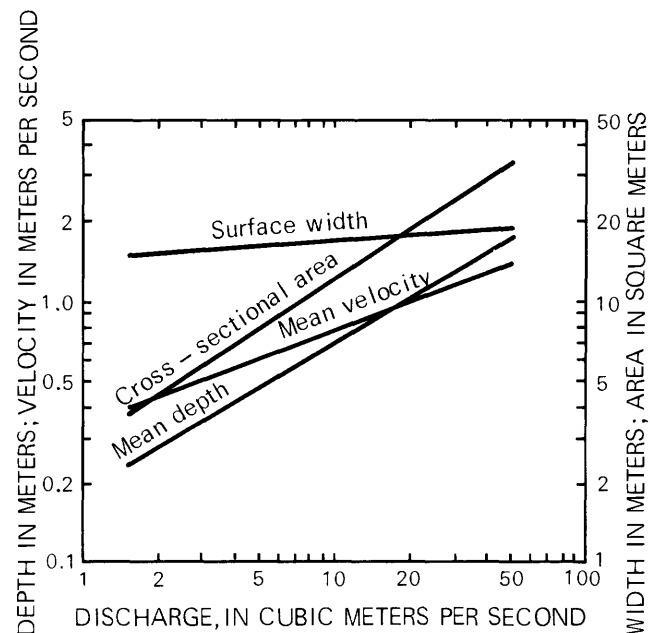

FIGURE 8.—Hydraulic-geometry relations for the East Fork River at the bedload trap.

trap have been previously published (Leopold and Emmett, 1976, 1977), and the same authors are presently preparing an interpretative report utilizing these data. Some of the data have been incorporated into a report (Mahoney and others, 1976) which compiled information necessary for calibrating unsteady-flow sediment-transport models. This latter report principally contains data of cross-sectional changes (scour and fill) at a number of sections in the 5-km reach of channel upstream of the bedload trap. Two doctoral dissertations (Lisle, 1976; Andrews, 1977) provide additional information about the fluvial characteristics of the East Fork River in the vicinity of the bedload trap. Use of the conveyor-belt facility for field calibration of the Helley-Smith bedload sampler covered the period 1973-76, but principal data collection for the field-calibration purpose was May-June, 1975. The writer had sole responsibility for the Helley-Smith bedload-sampling program.

SAMPLING TECHNIQUES WITH HELLEY-SMITH BEDLOAD SAMPLER

Although the Helley-Smith bedload sampler is in widespread use by the U.S. Geological Survey and other Federal and State agencies, and by university and private organizations, it has not been officially sanctioned by the Federal Inter-Agency Sedimentation Committee (Water Resources Council) nor certified for its technical performance by the U.S. Geological Survey. This certification is awaiting completion of rigorous laboratory testing of the sediment-trapping characteristics of the sampler under direction of the U.S. Geological Survey and the Federal Inter-Agency Sedimentation Committee. Although laboratory testing is now underway, it appears that the early 1980's is a reasonable target date for completion of testing and certification (or possible rejection) of the sampler.

Widespread use of the sampler, but lack of certification, combine to create some confusion with sampling procedures. No formal technique manual for use of the sampler exists, and instructions for its use are generally passed on by word of mouth from user to newcomer. Even on an interim basis, this procedure is acceptable only if the user passes along instructions based on reliable past use of the sampler.

The writer has collected more than 10,000 individual bedload samples with the Helley-Smith sampler. This experience, combined with gained insight of temporal and spatial variabilities in bedload-transport rates, has enabled him to establish a sampling procedure for the Helley-Smith sampler which gives consistent results.

The spatial or cross-channel variations in bedload-transport rates are significant. Frequently, all or most

of bedload transport occurs in a narrow part of the total width of channel. Though this narrow width of significant transport is generally stationary, it can shift laterally with changes in hydraulic conditions or sediment characteristics. Therefore, knowledge of where maximum or all bed load transport had occurred previously is not a criterion for eliminating a portion of channel width from the sampling program. At least 20 equally spaced, cross-channel sampling stations are necessary to insure that zones of both maximum and minimum transport are adequately sampled. (For large rivers and small rivers, the technique may be modified so that sections are not spaced greater than 15 m apart, nor is there apparent need for spacing sections closer than 0.5 m.)

Temporal variations in bedload-transport rates may also be large. This variation with time is obvious for the stream channel with movement of dunes, but even in gravel-bed rivers with no apparent dunes or migrating bedform, bedload transport may occur in slugs of sediment and show distinct cyclic trends with time. The frequency of the cyclic trend is dependent on the velocity and wavelength of the bedform or slug of sediment. Obviously, a precise procedure would be to sample at each cross-channel station until a reliable mean transport rate was established at each cross-channel location, but time requirements prohibit this detail.

The adopted procedure, a compromise between effort expended and idealized precision (in reality, little precision is lost), is to conduct two traverses of the stream and to sample at least 20 sections on each traverse. The spatial factor is covered by the 20 sections; the temporal factor is covered both because of the time expended during a single traverse of the stream and the time lag at each section as the second traverse is conducted. A comparison of values of mean transport rate, determined by multiple traverses of the stream, shows little change in the mean value by the addition of more than two traverses. Further, because of changes in the river hydraulics with time, and with each traverse of the river being time consuming, it is often impossible to conduct more than two traverses of the river and have the data considered as instantaneous or existing simultaneously. Each sample collected with the Helley-Smith bedload sampler requires about 2 to 3 minutes for lowering, sampling, raising, emptying, and moving to a new cross-channel location. A typical traverse thus requires about 1 hour; two traverses require about 2 hours. The time required to complete the double traverse generally allows a minimum of several cycles to be sampled in the cyclic trend of transport; this appears adequate to average temporal variations in transport.

For the East Fork River sampling program, all bed-

load occurs over the 14.6-m length of the gated slot in the streambed. Eight gates constitute this width; bedload sampling with the Helley-Smith sampler was made at the 1/6, 1/2, and 5/6 points of each gate (centroid of each third of gate length). Thus, 24 cross-channel sections constituted the cross-channel frequency of sampling for the East Fork River. Two traverses of the stream total to 48 individual Helley-Smith type samples, which are averaged to give a mean bedload-transport rate and used in the comparison with a mean bedload-transport rate for the conveyor-belt sampler.

The suspension bridge across the East Fork River at the bedload trap provided access across the river. The Helley-Smith sampler was lowered by cable to the streambed, timed for a duration of 30 seconds, and retrieved. By lowering the sampler from the upstream side of the bridge and placing the sampler on the streambed just upstream from the conveyor belt, simultaneous collections of data could be made with both sampling devices. Though efforts were made to have simultaneity in sampling, in reality, varying lengths of time were required to complete data collection by the two sampling methods. A slightly different mean stage or discharge may be recorded for the time period of Helley-Smith type sampling versus that for the conveyor-belt sampling. The differences were not consistent in biasing one method of sampling and were always minor. A later section of this report shows the results of corrections made to the measured bedload data to compensate for slight mean-discharge differences for data sets that were designed to be contemporary.

Generally, each Helley-Smith type bedload sample was individually bagged and later air dried, sieved, and weighed. Data thus collected could be later analyzed for cross-channel variability in transport rate and particle size or composited by gate length or whole-stream width for a comparison with the conveyor-belt data. Although many data are available for a gate-by-gate comparison of the conveyor-belt and Helley-Smith sampling methods, all data of this report are for stream-wide mean values. Thus, each point of comparison involves 48 Helley-Smith bedload samples and, generally, several hours of conveyor-belt operation. Totally, 100 runs were made with the conveyor belt, and 83 runs were made with the Helley-Smith sampler. All data are useful in separate analyses of percentage of total load in each particle-size class, and these analyses may be compared by method of collection. In addition, concurrent runs by the two methods can be compared directly. Comparison of total bedload-transport rates as measured by the two methods does not require knowledge of particle-size distri-

bution. In this instance, there are 74 matched sets of data available for direct comparison. For a comparison on a given particle size basis, various runs combine to give 61 simultaneous or matched data sets. Both the separate analyses and the direct comparisons are the results described in the next section.

Figure 9 illustrates some of the techniques and procedures involved with use of the Helley-Smith bedload sampler.

RESULTS OF FIELD-CALIBRATION TESTS

All basic data of the study are summarized in tables 4–7. Measured and computed river hydraulic data and measured bedload-transport rates are listed in tables 4 and 6 for the conveyor-belt sampler and Helley-Smith sampler, respectively. Particle-size distributions of bedload for the transport rates listed in tables 4 and 6 are given in tables 5 and 7 for the conveyor-belt sam-

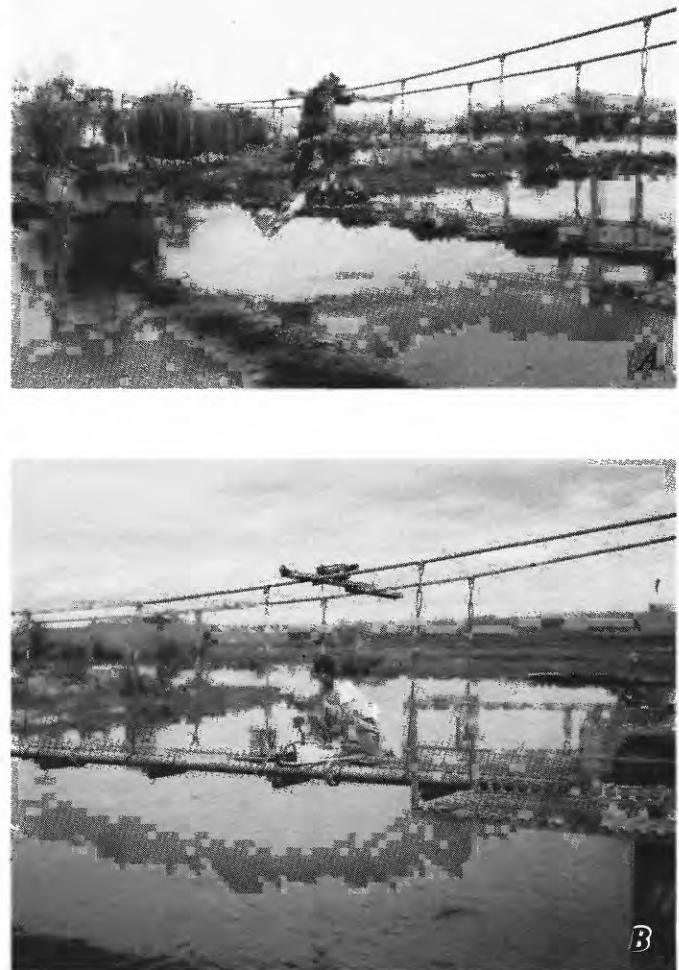

FIGURE 9.—Bedload sampling with the Helley-Smith bedload sampler. *A*, Preparing to lower sampler at relatively high flow rate. *B*, Preparing to empty sampler.

pler and the Helley-Smith sampler, respectively. For all analyses of this report, transport rates for given particle-size classes were obtained by multiplying total bedload-transport rate (tables 4 and 6) times the percent retained, by weight, in each particle-size class (from tables 5 and 7). This voluminous set of data was stored in computer memory during analysis of data, but since it can be easily duplicated, tabulations of it are not reproduced in this report. Although sieve analyses were conducted by half-phi increments (factor of $\sqrt{2}$), transport rates by particle-size class were analyzed by whole-phi increments (factor of two). This gave nine particle-size classes ranging in particle size from 0.06 mm to 32 mm; for the conveyor-belt sampler, several particles larger than 32 mm were measured, but these did not constitute a large enough sample to establish a reliable data set.

BEDLOAD-TRANSPORT RATES BY INDIVIDUAL PARTICLE-SIZE CATEGORIES, BASIC DATA

Relations of the bedload-transport rate in each particle-size class as functions of total bedload-transport rate were determined for both methods of sampling. The statistical procedure utilized was a least-squares linear regression of log-transformed data, giving a power equation of the form:

$$Y = AX^B,$$

or more specifically:

$$j_b \text{ (size class)} = Aj_b(\text{total})^B,$$

where j_b is the dry weight unit bedload-transport rate in kilograms per meter-second.

Data of the statistical analyses are presented in tables 8 and 9 for the conveyor-belt sampler and the Helley-Smith sampler, respectively. Graphs of basic data and statistical analyses are illustrated in figures 10-18 for various particle-size classes; for each method of sampling, graphs show the least-squares fit to the data and, superimposed, the least-squares fit to the data of the alternate method of sampling.

Of special interest is the percentage of total bedload occurring in each particle-size class. Utilizing mean values of X and Y data and summarizing from tables 8 and 9:

Particle-size class (mm)	Mean percentage of total bedload in particle-size class (\bar{Y}/\bar{X})	
	Helley-Smith	Conveyor-belt
0.06- 0.12	0.35	0.32
.12- .25	3.24	1.74
.25- .50	22.89	18.49
.50- 1.00	26.84	27.89
1.00- 2.00	20.07	21.89
2.00- 4.00	10.61	13.87
4.00- 8.00	3.45	5.56
8.00- 16.00	.89	1.49
16.00- 32.00	.65	.74

Mean percentages in the above table do not add to 100, because the mean value of total bedload is variable. That is, larger particles move only during higher transport rates, and the mean value of total bedload transport is, obviously, greater during those instances. The effect is to decrease the apparent mean percentage of total bedload in the larger particle-size classes; the adequacy in sampling of large particles will be discussed subsequently.

Before continued discussion, it is also of interest to note the rate of change in the above percentages as the actual bedload-transport rate increases or decreases. This rate of change is described by the exponent of the regression equations, B . Summarizing from tables 8 and 9:

Particle-size class (mm)	Rate of change in percentage of total bedload in particle-size class (B)	
	Helley-Smith	Conveyor belt
0.06- 0.12	0.727	0.663
.12- .25	.599	.553
.25- .50	.698	.742
.50- 1.00	1.050	1.000
1.00- 2.00	1.213	1.173
2.00- 4.00	1.344	1.278
4.00- 8.00	1.193	1.211
8.00- 16.00	.867	.995
16.00- 32.00	.387	.926

Because the mesh size of the sample-collection bag used on the Helley-Smith sampler was 0.20 mm, data of the first two particle-size categories tabulated above should be disregarded. Probably quite by coincidence, the amount of 0.06 to 0.12 mm size sediment trapped by the conveyor-belt sampler (insignificantly at 0.3 percent) is nearly identical to the amount of same-size material that was trapped in, rather than washed through, the Helley-Smith sample-collection bag.

The Helley-Smith sampler collects nearly twice as much sediment in the 0.12 to 0.25 mm size class as the conveyor-belt sampler. However, not only is the catch in the Helley-Smith sampler not valid because of the mesh size of the collection bag, but also analysis of suspended-sediment size data indicates this particle-size class represents the dominant particle sizes of suspended sand. Thus, the Helley-Smith sampler, which protrudes into the flow, is receiving an abundance of this size suspended sediment, some of which is trapped but the majority of which is washed through the sample bag.

For sediment in the 0.25 to 0.50 mm particle-size class, both samplers must retain all sediment which is supplied to them. The Helley-Smith sampler shows a greater mean percentage of total bedload in this size class than does the conveyor-belt sampler, but again, analyses of suspended-sediment data show appreciable quantities of this size sediment in suspension. Certainly the collection of some suspended sediment by the

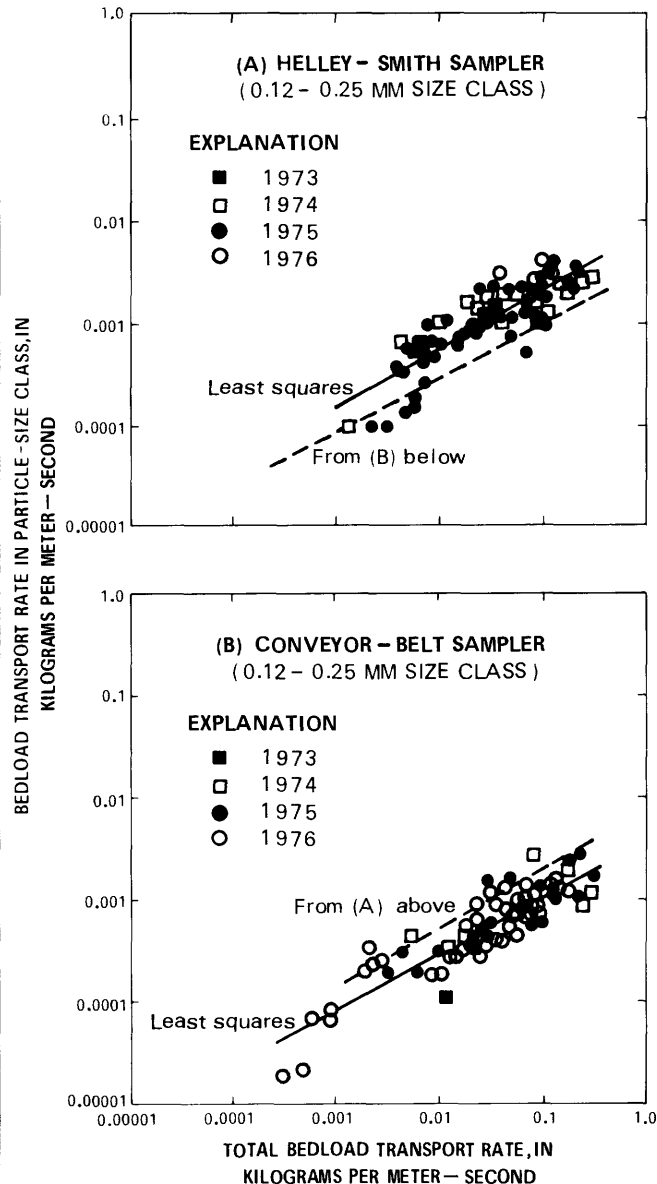
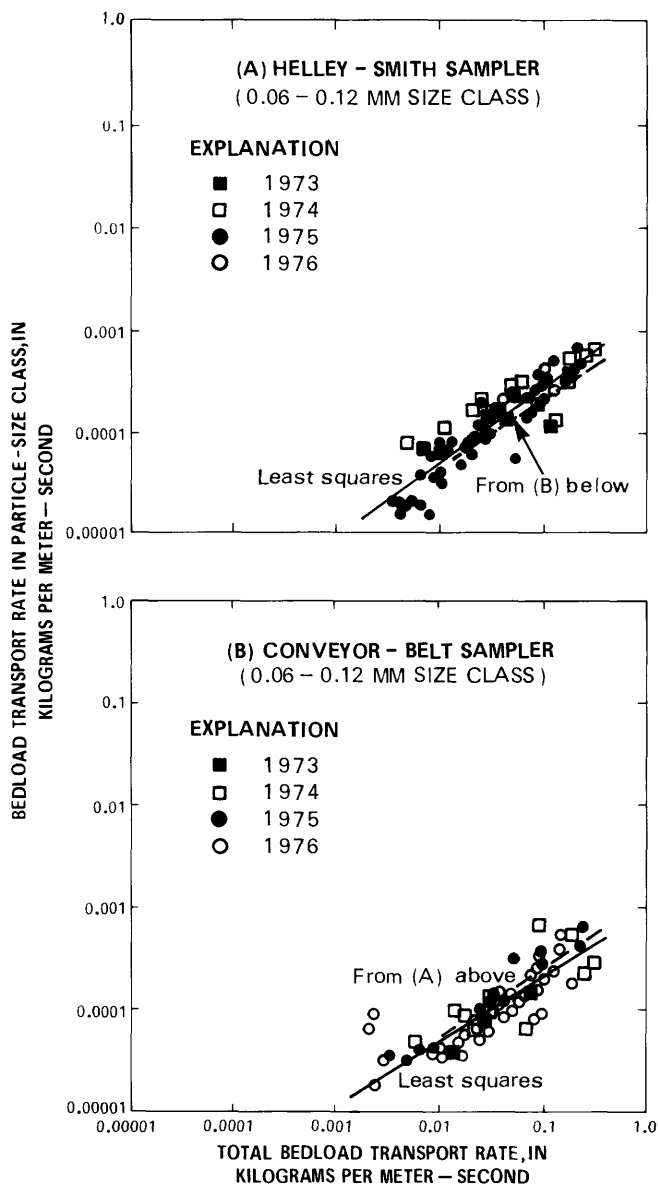

FIGURE 10.—Relation of bedload-transport rate in individual-size category as function of total bedload-transport rate; 0.06–0.12 mm size class.

Helley-Smith sampler is an explanation for its greater mean percentage in this size category, but a quantitative description of how much of it is attributable to this effect is not possible. It is most important to recognize that the Helley-Smith sampler does receive suspended sediment, and the absolute quantities of it are dependent on the sizes of sediment in transport and hydraulic characteristics of the flow—factors which are different for every stream and thus cannot be calibrated.

Complete analysis of suspended-sediment size data for the East Fork River shows no significant quantity of suspended sediment larger than 0.50 mm. For material capable of being moved in suspension (<0.50 mm), its significance as bedload decreases as bedload-

FIGURE 11.—Relation of bedload-transport rate in individual-size category as function of total bedload-transport rate; 0.12–0.25 mm size class.

transport rate increases. This is reflected in the rate of change values (exponent *B*) tabulated above. The values for suspended-sediment size particles are less than unity, indicating that as total bedload-transport rate increases, the percentages of sediment in those size classes decrease.

For sediment in the four particle-size classes ranging in size from 0.50 to 8.0 mm, significant bedload transport occurs, and the significance increases as the total bedload-transport rate increases. The dominant particle-size class of bedload is 0.50 to 1.0 mm and accounts for a little over one-fourth of the total bedload (recall also the size distribution of composited bedload, table 2). The greatest rate of change in percentage of

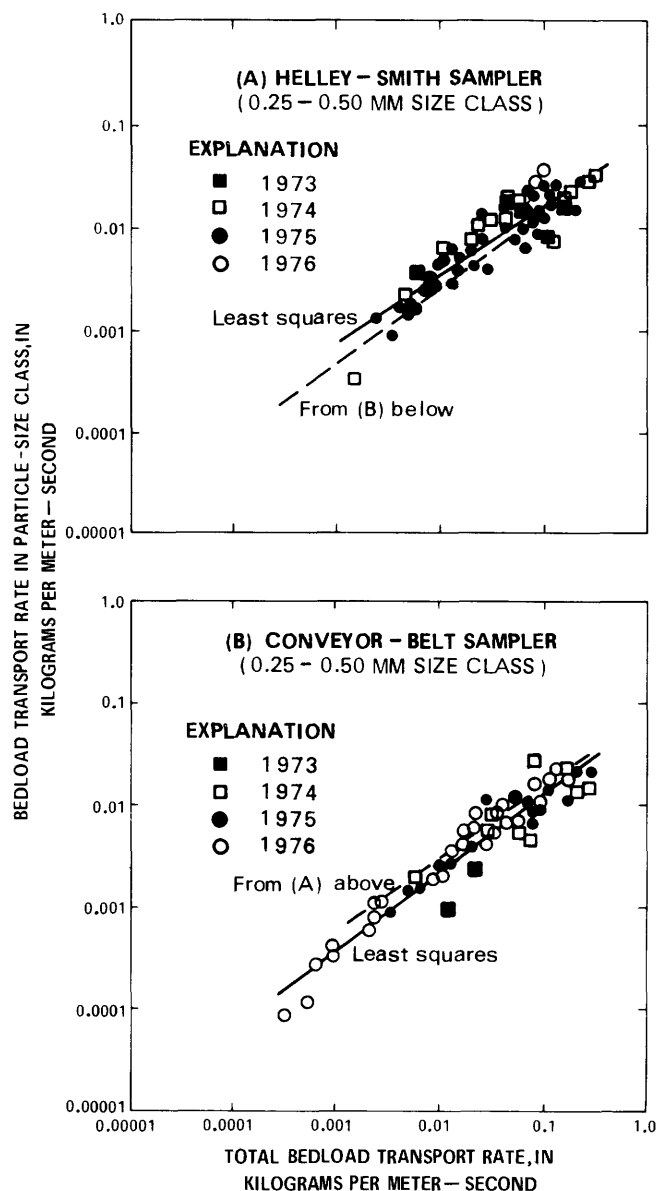

FIGURE 12.—Relation of bedload-transport rate in individual-size category as function of total bedload-transport rate; 0.25-0.50 mm size class.

total bedload in a given particle-size class occurs for particles in the size class of 2.0 to 4.0 mm, followed by size classes 1.0 to 2.0 mm and 4.0 to 8.0 mm. These rates of change values combine with the mean percentage values such that at high bedload-transport rates the percentage of total bedload is actually greatest in particle-size categories of 1.0 to 2.0 mm and 2.0 to 4.0 mm. This leads to a median particle size of composited bedload being 1.13 mm (table 3).

For sediment sizes greater than 8.0 mm, only about ½-2 percent of the total bedload occurs in the particle-size categories of 8 to 16 mm and 16 to 32 mm. The mean transport rate for these size particles is about

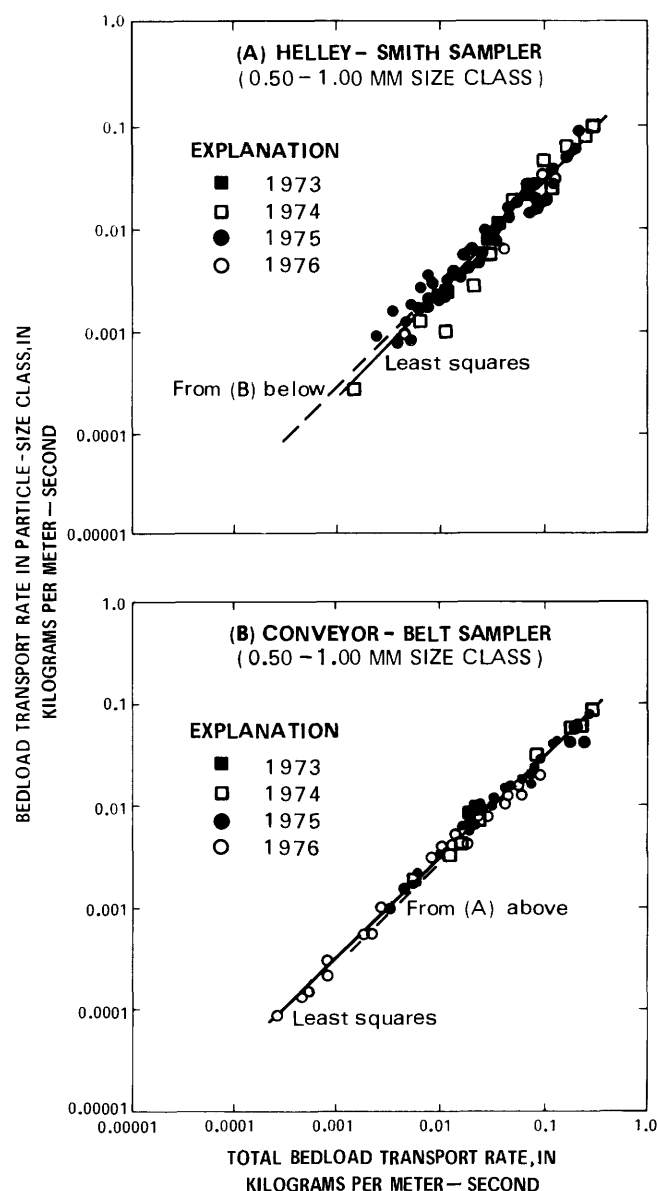

FIGURE 13.—Relation of bedload-transport rate in individual-size category as function of total bedload-transport rate; 0.50-1.00 size class.

0.0004 kg/m-s (tables 8 and 9). The average 32-mm particle weighs about 55 grams, and the average 16-mm particle weighs about 6.8 grams. These numbers can be manipulated to show that, streamwide, only about three 32-mm particles and twenty-five 16-mm particles pass down river every 30 seconds, the duration of sampling with the Helley-Smith sampler. Since the Helley-Smith sampler covers only about 0.5 percent of the stream width (76.2 mm nozzle/14.62 m wide), the Helley-Smith sampler has somewhat less than a 2 percent chance of collecting a 32-mm particle and about a 15 percent chance to collect a 16-mm particle. This is additionally reflected in the number of ob-

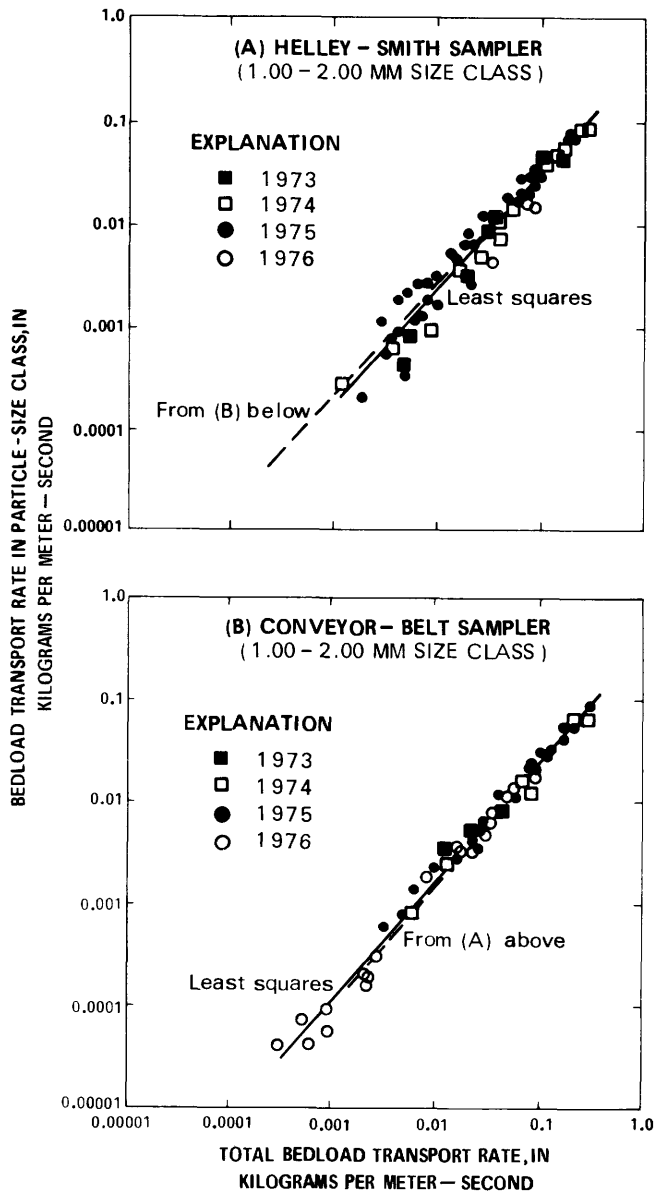

FIGURE 14.—Relation of bedload-transport rate in individual-size category as function of total bedload-transport rate; 1.00–2.00 mm size class.

servations recorded in tables 8 and 9. While nearly 50 percent of the runs with the conveyor-belt sampler included trapping a particle of size 16–32 mm, fewer than 25 percent of the runs with the Helley-Smith sampler included trapping a particle of that size. Thus, the transport rate for large particles in the East Fork River was too minimal to allow reliable calibration for particles larger than about 8 mm, perhaps to 16 mm.

It should also be pointed out that the rate-of-change data for the two coarsest size categories are misleading. Since the largest particles move only at high transport rates, many low transport runs are not included in the analysis for these size particles. By this

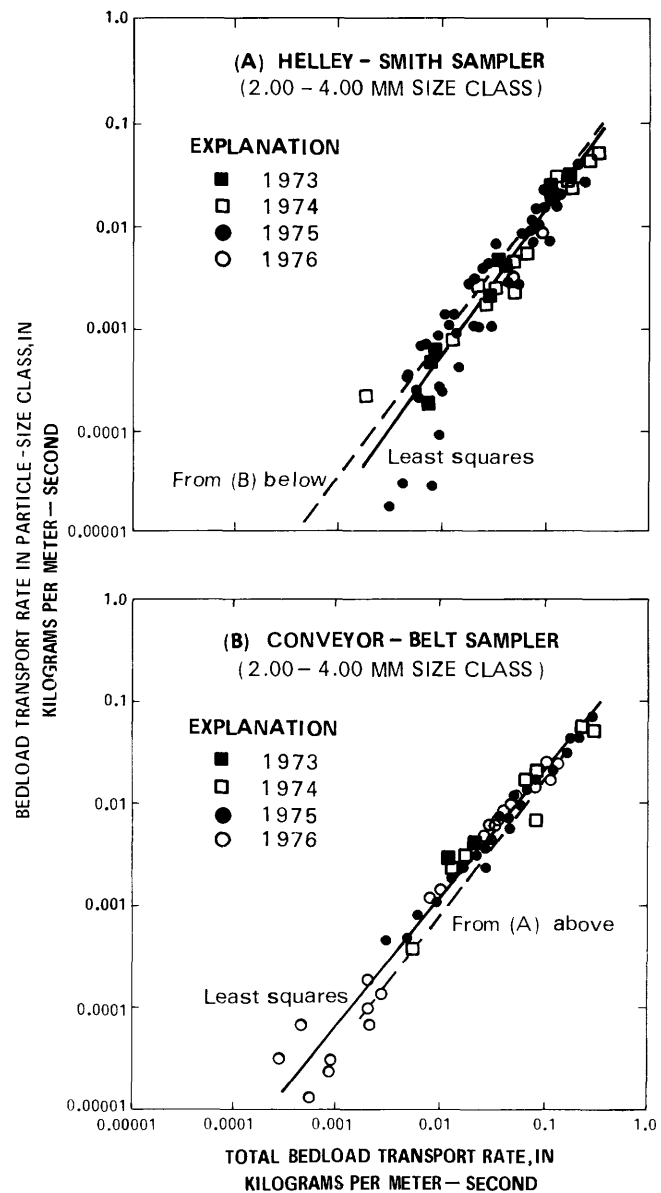

FIGURE 15.—Relation of bedload-transport rate in individual-size category as function of total bedload-transport rate; 2.00–4.00 mm size class.

fact alone, large particles begin their significance at high transport rates and increase from there. Because zero values cannot be used in log-transformed regressions, values of rate of change (slope of the regression equation) comparable to the smaller particle-size categories cannot be quantitatively determined.

This section of the results has concentrated on analysis of bedload-transport rates by individual particle-size categories as functions of total bedload-transport rate. Its primary purpose is to place reliability limits on the comparability of data collected and was used to show that for particle sizes less than 0.50 mm, the influence of suspended sediment casts doubts

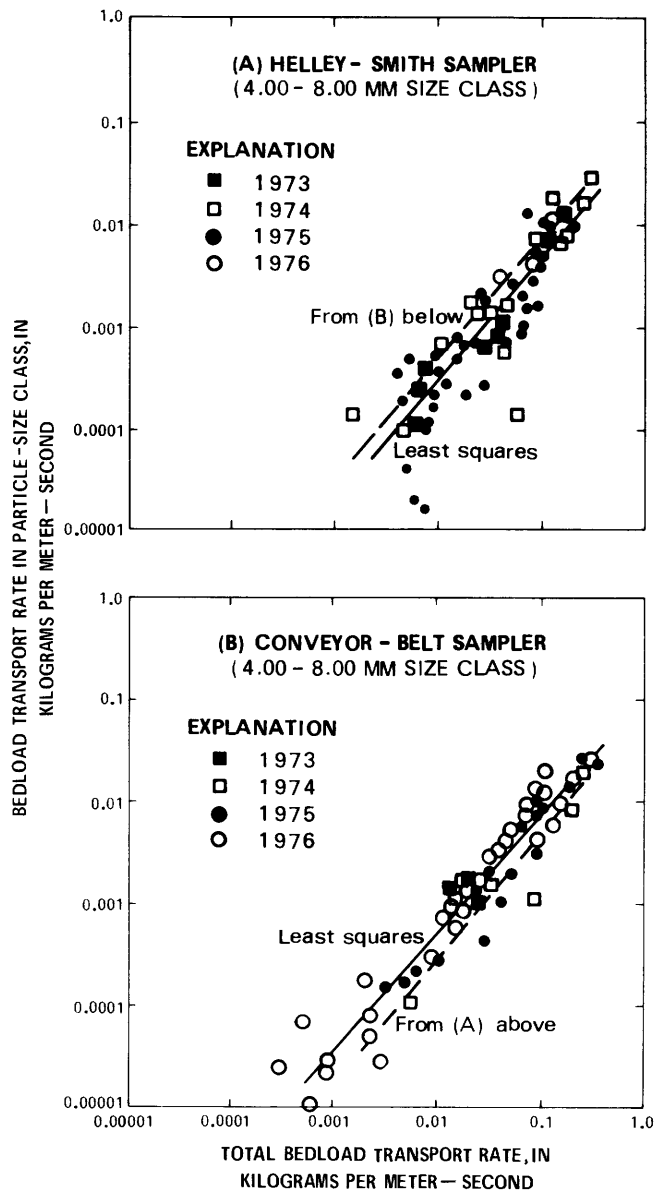

FIGURE 16.—Relation of bedload-transport rate in individual-size category as function of total bedload-transport rate; 4.00-8.00 mm size class.

on comparability (not reliability) of data collected with the Helley-Smith sampler. For particle sizes less than 0.20 mm (mesh size of the bag), data collected with the Helley-Smith sampler should be discarded. For particle sizes larger than 8.0 to 16 mm, paucity of individual particles moving probably prohibits the Helley-Smith sampler from collecting a representative sample, and data should be treated with caution.

The above analyses and discussion are not applicable to a direct comparison between the Helley-Smith sampler and the conveyor-belt sampler, because the analysis utilized all available data rather than matched data sets. For example, many data collected at

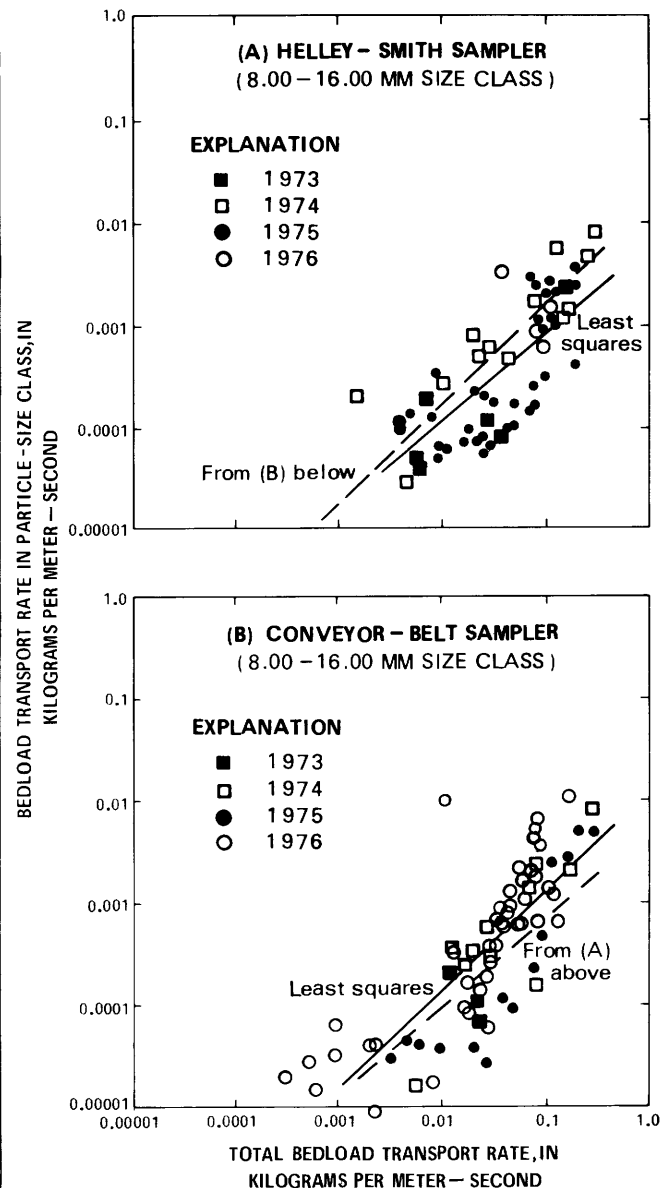

FIGURE 17.—Relation of bedload-transport rate in individual-size category as function of total bedload-transport rate; 8.00-16.0 mm size class.

low transport rates in 1976 with the conveyor-belt sampler were not obtained with the Helley-Smith sampler; this created a data base with a mean transport rate that is different between the two methods of sampling. The next section discusses a direct comparison of the two methods of sampling.

COMPARISON OF HELLEY-SMITH RESULTS WITH CONVEYOR-BELT RESULTS, BASIC DATA

Data collected concurrently with both the Helley-Smith sampler and the conveyor-belt sampler may be compared directly one against the other; a total of 74

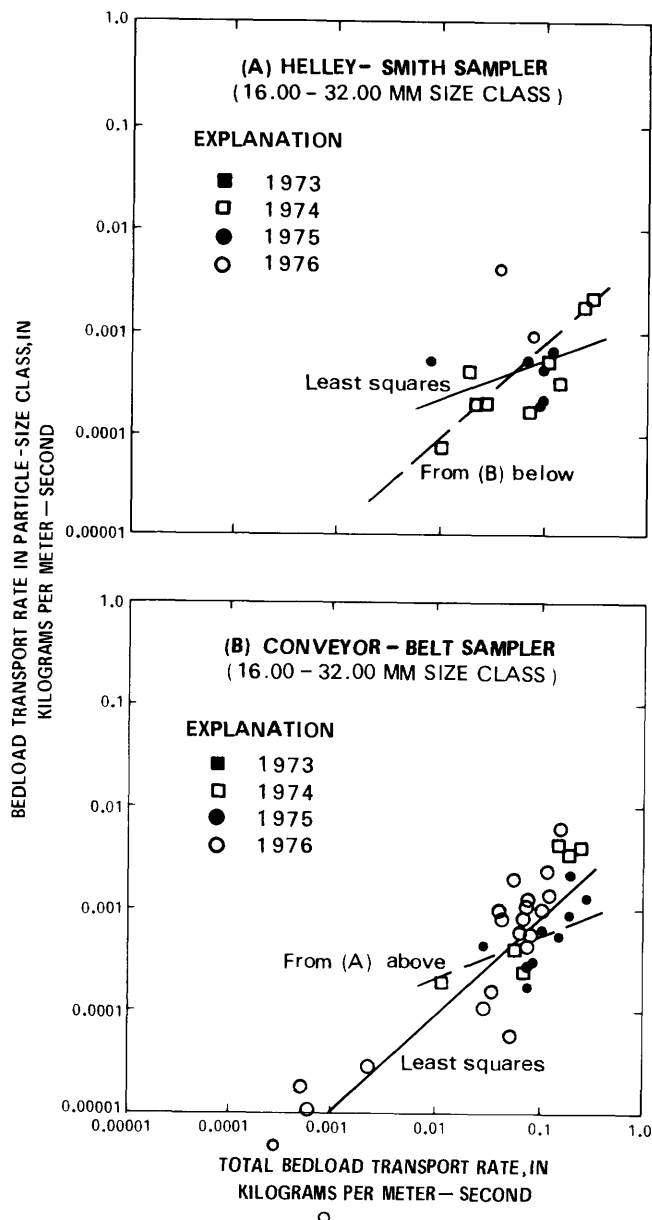

FIGURE 18.—Relation of bedload-transport rate in individual-size category as function of total bedload-transport rate; 16.0-32.0 mm size class.

such matched sets of data exists. Some of these data sets are composed of a single run with the conveyor-belt sampler and two runs during the same time with the Helley-Smith sampler, thus giving two points of comparison. Of the 74 data sets, some runs with the conveyor-belt sampler are lacking particle-size analyses. For comparisons made at given particle-size classes, 61 matched sets of data are available. Table 10 lists matching of data sets as used in the present and next sections of this report.

Comparisons of the bedload-transport rate in each particle-size class were made with the Helley-Smith

sampler results expressed as functions of the conveyor-belt sampler results. As in the previous section of this report, the statistical procedure utilized was a least-squares linear regression of log-transformed data, giving a power equation of the form:

$$Y = AX^B,$$

or, for this analysis:

$$j_b(\text{Helley-Smith}) = A j_b(\text{conveyor belt})^B,$$

where j_b is the dry-weight unit bedload-transport rate in kilograms per meter-second.

Results of the statistical analysis are presented in table 11. The sample means of the log-transformed transport rates ($\log \bar{Y}$ and $\log \bar{X}$) and the standard deviations of the transformed values ($SD(\log Y)$ and $SD(\log X)$) are given in table 11 (top) for each particle-size class; also given are the computed intercept ($\log A$) and slope (B) for the transformed data, the estimated variances for these parameters (see Draper and Smith, 1966, section 1.4), and the values of the multiple correlation coefficient, r^2 , for the regressions. Table 11 (bottom) lists the means for the transport rates before the log transformation (\bar{Y} and \bar{X}), the ratio \bar{Y}/\bar{X} , and the values of A and $SE(A)$ (computed by taking the antilogs of $\log A$ and $SE(\log A)$, respectively).

The quantities $SE(\log A)$ and $SE(A)$ should be interpreted as follows: a confidence interval for the intercept $\log A$ can be constructed by taking the lower limit of the interval to be $\log A - \text{constant}(SE(\log A))$ and the upper limit to be $\log A + \text{constant}(SE(\log A))$. The limits of the corresponding interval for A are obtained by taking $A \div (SE(A)) \text{ constant}$ and $A \times (SE(A)) \text{ constant}$. For a 95-percent confidence interval, the value of the constant is 1.96.

Graphs of basic data and statistical analyses are illustrated in figures 19-27 for various particle-size categories. Graphs show the least-squares fit to the data and, superimposed, the line of perfect agreement. Summarized below are salient data of table 11, utilizing the mean values of the regression statistics.

Particle-size class (mm)	Mean ratio in transport rate; Helley-Smith:conveyor belt (\bar{Y}/\bar{X} , in percent)	Rate of change in ratio of transport (B)
0.06- 0.12	123.08	0.928
.12- .25	211.66	.751
.25- .50	149.98	.802
.50- 1.00	98.70	.934
1.00- 2.00	89.36	.868
2.00- 4.00	86.43	.803
4.00- 8.00	93.81	.739
8.00- 16.00	93.58	.747
16.00-32.00	55.67	.501

If values of the exponent B were equal to 1.0, regression relations would be linear. To test the hypothesis

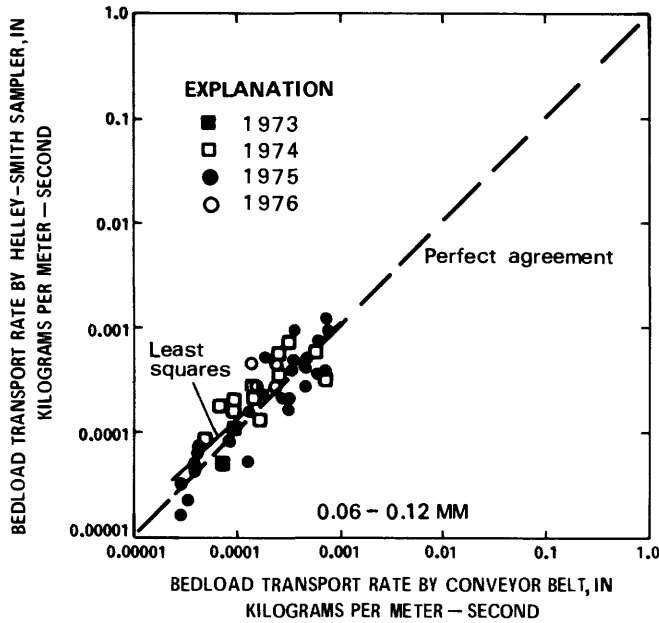

FIGURE 19.—Comparison of bedload-transport rate by individual particle-size category, Helley-Smith sampler versus conveyor-belt sampler; 0.06–0.12 mm size class.

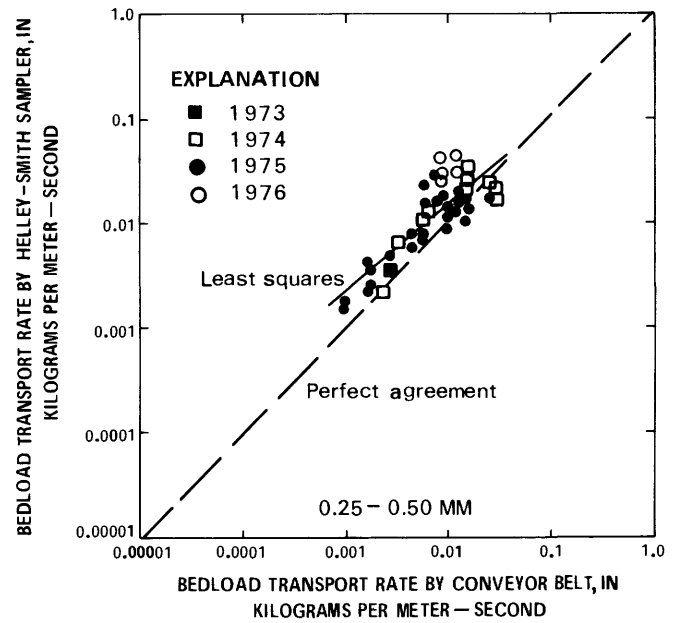

FIGURE 21.—Comparison of bedload-transport rate by individual particle-size category, Helley-Smith sampler versus conveyor-belt sampler; 0.25–0.50 mm size class.

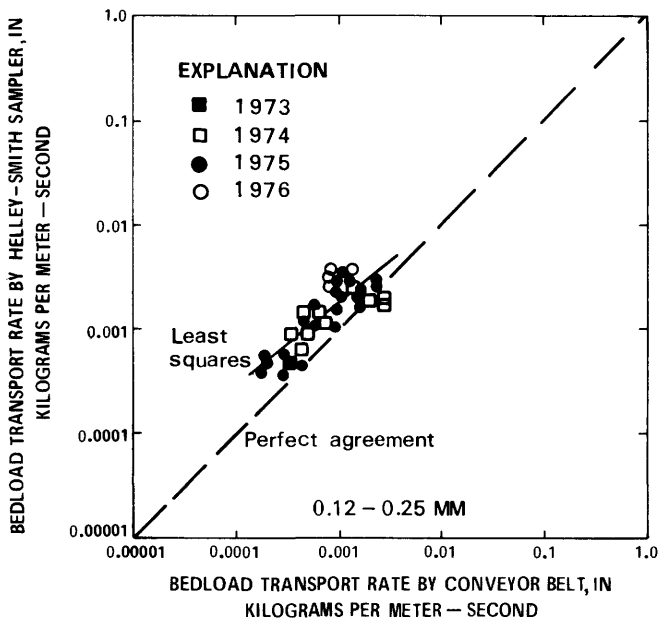

FIGURE 20.—Comparison of bedload-transport rate by individual particle-size category, Helley-Smith sampler versus conveyor-belt sampler; 0.12–0.25 mm size class.

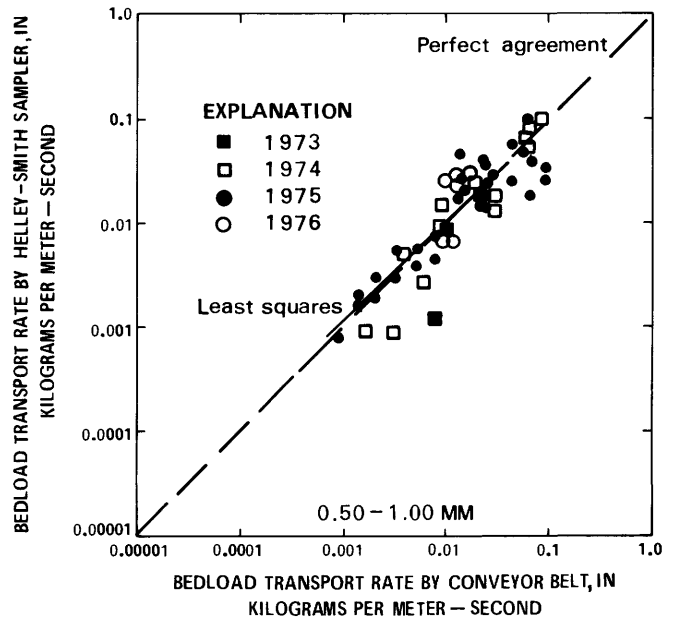

FIGURE 22.—Comparison of bedload-transport rate by individual particle-size category, Helley-Smith sampler versus conveyor-belt sampler; 0.50–1.00 mm size class.

that the slope = 1.0 at the 5 percent level of significance, a 95-percent confidence interval is constructed by taking

$$B \pm 1.96 (SE(B)),$$

and the hypothesis is rejected if 1.0 does not lie in the interval. The upper limit of the interval attained

values ranging from 0.85 to 1.07. Although several regression equations had values of slope = 1.0 within the interval, and all values of slope indicated relations approaching linearity, the hypothesis that regression relations are linear must be rejected. Implications of the nonlinearity will be discussed in a later part of this section of the report.

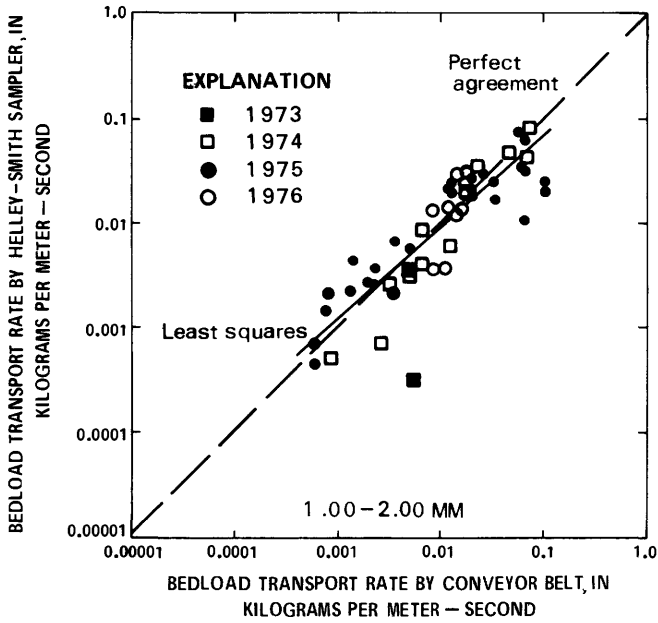

FIGURE 23.—Comparison of bedload-transport rate by individual particle-size category, Helley-Smith sampler versus conveyor-belt sampler; 1.00–2.00 mm size class.

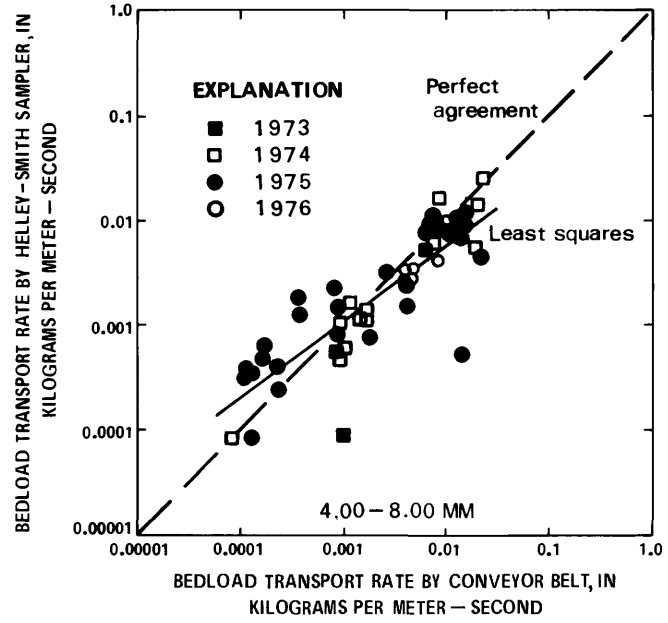

FIGURE 25.—Comparison of bedload-transport rate by individual particle-size category, Helley-Smith sampler versus conveyor-belt sampler; 4.00–8.00 mm size class.

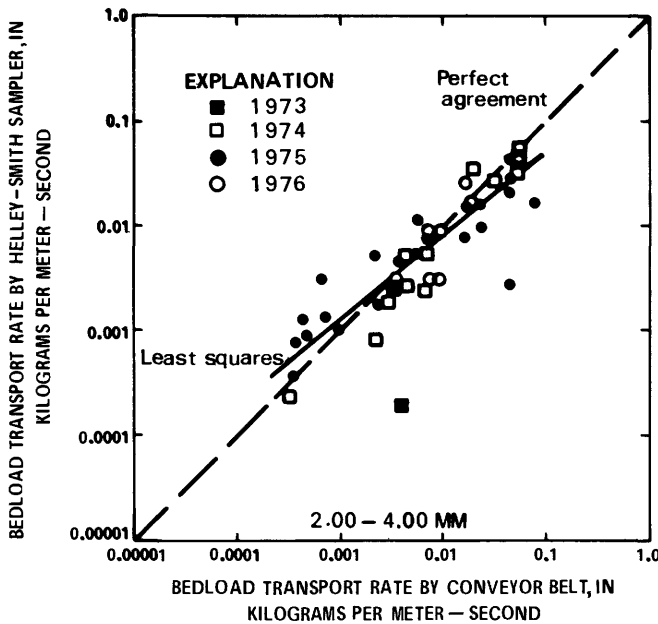

FIGURE 24.—Comparison of bedload-transport rate by individual particle-size category, Helley-Smith sampler versus conveyor-belt sampler; 2.00–4.00 mm size class.

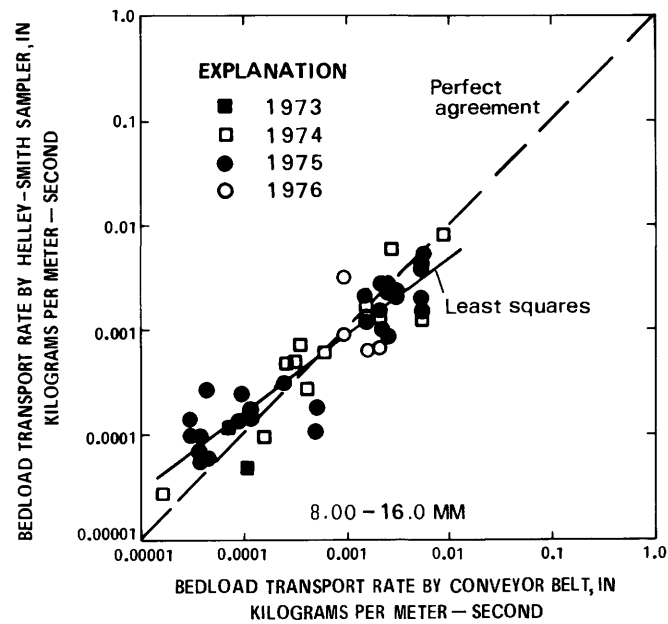

FIGURE 26.—Comparison of bedload-transport rate by individual particle-size category, Helley-Smith sampler versus conveyor-belt sampler; 8.00–16.0 mm size class.

For particle sizes less than 0.50 mm, the effect of the Helley-Smith sampler catching suspended sediment is apparent. Sampling efficiency as determined for particle sizes less than 0.25 mm should be discounted because of mesh-size limitations of the sample-collection bag. Data show that for sediment in the particle-size class of 0.25 to 0.50 mm, the Helley-Smith sampler is

about 150 percent efficient; this efficiency factor is valid only for the East Fork River and is dependent on the particular ratio of suspended load to bedload.

For particle sizes between 0.50 and 16 mm, the Helley-Smith sampler traps approximately the same amount of sediment as the conveyor-belt sampler. Average sampling efficiency for particle-size classes be-

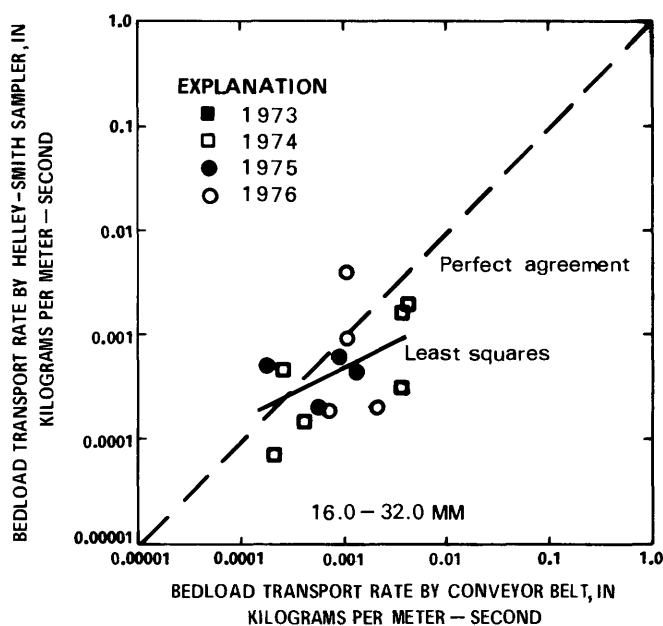

FIGURE 27.—Comparison of bedload-transport rate by individual particle-size category, Helley-Smith sampler versus conveyor-belt sampler; 16.0–32.0 mm size class.

tween 0.50 and 16.0 mm ($\Sigma\bar{Y}/\Sigma\bar{X}$, from table 11) is 92.6 percent. The slopes of the regression equations indicate a decrease in the sediment-trapping efficiency of the Helley-Smith sampler as the bedload-transport rate increases. Reduction in trap efficiency appears modest, but if extrapolation is made beyond the range of measured data, the consequences may be great.

For particle sizes greater than 16 mm, the Helley-Smith sampler traps only about 50 percent of the sediment trapped by the conveyor-belt sampler. This decreased efficiency is probably related more to the paucity of large particles moving (as explained in the previous section) than to the characteristics of the sampler. The effect of a decreasing number of particles moving as particle size increases is also reflected in the decrease away from unity in values of the rate of change (slope of regression equations) tabulated above.

The adequacy of the above statistical treatment of the data has been discussed by M. deVries (oral communications, 1978) on the basis of work by deVries and his colleagues at the Delft Hydraulics Laboratory, Delft, The Netherlands. Whereas the author, thus far, has expressed results of regression equations with the conveyor-belt data as the independent variable,

$$j_b(\text{Helley-Smith}) = A j_b(\text{conveyor belt})^B,$$

deVries indicates that the regression should be expressed

$$j_b(\text{conveyor belt}) = A' j_b(\text{Helley-Smith})^{B'}.$$

Mathematically, the above equations express the same relation, but as far as the statistical analysis is concerned, they differ. DeVries points out that in practice the calibration curve is used to compute the actual transport rate from the measured rate obtained using the Helley-Smith sampler. This would suggest that the second relation above should be used. The author agrees that an end product might be a curve enabling determination of real transport rate from a sampling of transport rate obtained with a Helley-Smith bedload sampler. On the other hand, the purpose of the present study is an evaluation of the agreement that data collected with the Helley-Smith sampler have with data collected with the conveyor-belt sampler. As such, correct experimental and analytical procedures would demand that data collected with the conveyor belt be treated as the independent variable. Assumptions or statements of fact relating measurements with the conveyor-belt apparatus to real transport rates may then be used to imply the relation to true transport rates that exists with measurements obtained with the Helley-Smith sampler. It was implied in an earlier section of this report that the conveyor-belt apparatus measured the true bedload-transport rate; still, statistical analysis of the present data involves a comparison of the Helley-Smith bedload sampler to the conveyor-belt sampler. A later section of this report discusses both some shortcomings in data collected with the conveyor belt and the statistical significance in reversing the dependence and independence of the variables.

DeVries also points out that calibration of bedload samplers implies that the reading from the sampler is compared to the real value. Calibration, as in this investigation, usually consists of comparing average values of the observations, \bar{j}_b (Helley-Smith), with average values of the real transport, \bar{j}_b (conveyor belt), the latter being assumed to be the real transport. But, if a nonlinear relation exists between the measured transport and the actual transport, average values cannot be used (as deVries points out, in the same way $\log x \neq \log \bar{x}$). Instantaneous measured transport should be compared to actual transport; however, it is impossible to measure actual momentary transport at the location of the sampler.

The Delft Hydraulics Laboratory (DHL, 1969) has circumvented this problem by means of a probability distribution of bedload-transport rate. Hamamori (1962), with deVries, developed a probability distribution of the ratio of instantaneous to average transport rates:

$$P(j_b/\bar{j}_b) = \frac{1}{4} (j_b/\bar{j}_b) \left(1 + \log \frac{4}{(j_b/\bar{j}_b)} \right),$$

where P indicates the probability of a value $\leq j_b/\bar{j}_b$.

This probability distribution is characterized by the largest instantaneous sample being 4 times the mean and 60 percent of the samples being smaller than the mean. It is not unlike probability distributions commonly used for meteorological data (e.g., rainfall), hydrological data (e.g., daily streamflows), or any other data sets where minimum values are zero and maximum values may be greater than twice the mean. That is, one large value may compensate for several small values so that the majority of values are smaller than the mean. Hamamori developed the probability distribution for the case of primary dunes with faster secondary ripples on top. DeVries reported to the writer that field data collected with the Arnhem sampler in the Panterden Channel (a branch of the Rhine River in The Netherlands) showed good agreement with the probability distribution; D. W. Hubbell (oral communication, 1978) reported good agreement of the probability distribution with data collected by Einstein during calibration tests for the Nesper bedload sampler; and significantly, there is good agreement with the minute-by-minute recordings of transport as measured with the conveyor-belt apparatus on the East Fork River, Wyoming.

If the instantaneous transport rates obey the relation

$$j_b(\text{Helley-Smith}) = A' j_b(\text{conveyor belt})^{B'}$$

and the average transport rates obey this relation with A' and B' replaced by A and B , it can be shown that

$$A' = \frac{1}{4} A \left(\frac{B+1}{B} \right) 2B$$

and

$$B' = B,$$

when the above probability distribution holds for the instantaneous rates. The effect on statistical data as presented in table 11 is summarized below.

Particle-size class (mm)	A	B	A'	A'/A	\bar{Y}/\bar{X} (percent)
0.06- 0.12	0.654	0.928	0.674	1.030	126.77
.12- .25	.348	.751	.390	1.122	234.48
.25- .50	.566	.802	.618	1.092	163.78
.50- 1.00	.743	.934	.763	1.027	101.36
1.00- 2.00	.498	.868	.527	1.057	94.45
2.00- 4.00	.329	.803	.359	1.091	94.30
4.00- 8.00	.192	.739	.217	1.129	105.91
8.00-16.00	.143	.747	.161	1.124	105.18
16.00-32.00	.016	.501	.022	1.332	74.15

The average effect is to increase the value of the coefficient by about 8 percent. The net effect, weighted

by transport rate for particle-size classes between 0.50 and 16.0 mm, is to increase the average sampling efficiency, $\Sigma\bar{Y}/\Sigma\bar{X}$, from 92.6 percent to 97.9 percent.

The brief discussion in this section has been based on a direct comparison of sediment trapped by the Helley-Smith sampler to sediment trapped by the conveyor-belt sampler using only basic data as collected. Two comparisons were made: one based on average values of transport as collected, and a second based on a conversion to real instantaneous transport. Certain modifications to the basic data can also be made; the modifications reflect refinements to the basic data and are based on auxiliary analyses designed to make the data sets more systematic and to allow for additional deficiencies in analytical procedures. These modifications are discussed in the next section; their influence and importance (or lack of it) will be reflected in the recommendations. Incorporation of modifications has been preceded by presentation of basic data in this and the previous section to allow more objective reasoning to what might be called subjective refinements.

MODIFICATIONS TO THE BASIC DATA

Rather than test the influence of various refinements to basic data on a particle-size class basis, testing was done on comparisons of total bedload as trapped by the two methods of sampling. Twelve refinements or combinations of refinements were attempted; statistical data of these attempts are included in table 12. For convenience, these data are summarized below and subsequently discussed individually.

Refinement (see subsequent discussion for detail)	Mean ratio in total bedload-transport rate Helley-Smith:conveyor belt (\bar{Y}/\bar{X} , in percent)	Rate of change in ratio of transport (B)
(1) None, basic data	109.14	0.790
(2) Helley-Smith independent, (1)	109.14	1.013
(3) Conveyor-belt corrected	124.49	.856
(4) (2), (3)	124.49	1.102
(5) Helley-Smith corrected, (3)	123.01	.867
(6) Variance corrected, (3), (5)	123.01	.927
(7) Excludes $d < 0.25$ mm, (3)	122.63	.885
(8) Excludes $d < 0.50$ mm, (3)	109.22	.916
(9) (3), (6), (8)	109.22	.979
(10) (3), (5), (7)	122.02	.896
(11) (3), (5), (8)	108.58	.927
(12) (3), (5), (6), (8)	108.58	.991

Item (1) above includes no modification to the data but is an expression of the regression equation for total bedload. Using abbreviations of *HS* for the Helley-

Smith sampler and *CB* for the conveyor-belt sampler, the relation is obtained:

$$HS = 0.55 CB^{0.79}, \quad (1)$$

with a mean sediment-trapping efficiency for the Helley-Smith sampler of 109 percent. This relation is graphed in figure 28.

To the eye, the least-squares relation shown in figure 28 is not overwhelmingly a better fit to the data than is the line of perfect agreement. This fact led to modification (2) which reverses the independent and dependent variables (or simply minimizes the squares along the abscissa rather than the ordinate). This leads to a relation:

$$HS = 1.15 CB^{1.01}, \quad (2)$$

which is quite different from relation (1) but utilizes the same statistical procedures. By necessity, the mean sediment-trapping efficiency for the Helley-Smith sampler remains at 109 percent. A graphing of this relation is shown in figure 29.

Leopold and Emmett (1976, 1977) have published more detailed information of the conveyor-belt data than is reproduced in this report. For the voluminous data of 1976, they showed in the 1977 publication the gate-by-gate transport data as well as stream-wide values obtained either by accumulating the gate-by-gate data or by operating the conveyor-belt with all gates open. For a number of the conveyor-belt runs, stream-wide data were collected utilizing both techniques of operation and representing approximately the same hydraulic conditions of flow. Analysis of these data shows that the sum-of-the-gates determination of stream-wide bedload was higher than the corresponding determination by operating with all gates open simultaneously and indicates an end effect at the gates when the gates were individually opened. The effect was not only consistent, involving every instance of data collection, but was significant. The overregistration by the individual gate method was a factor of 1.3 and was constant over the range of transport rates investigated.

Modification (3) involves dividing by the factor of 1.3 the conveyor-belt data which were collected by the individual gate method to correct the data for the equivalent stream-wide condition. Table 10 indicates which of the data were so corrected. This correction led to a regression equation:

$$HS = 0.76 CB^{0.86}, \quad (3)$$

and a mean sediment-trapping efficiency of 124 percent. A graph of the data and least-squares relation is shown in figure 30.

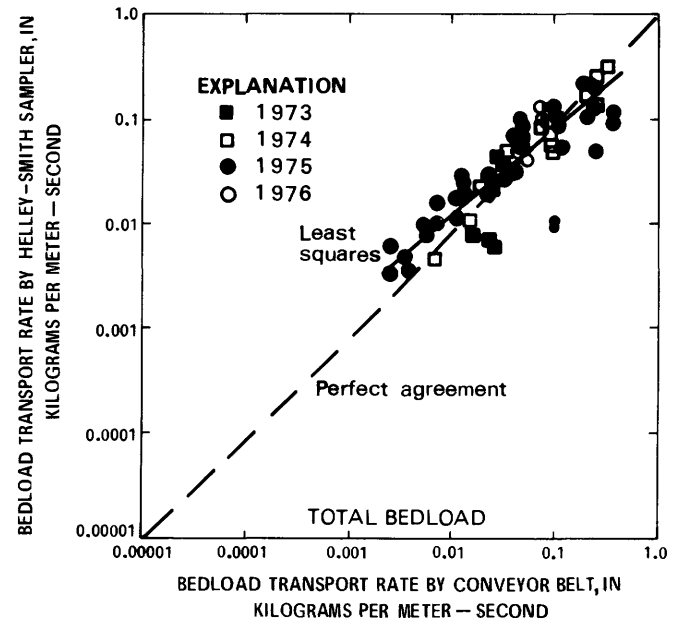

FIGURE 28.—Comparison of total bedload-transport rate; Helley-Smith sampler (dependent variable) versus conveyor-belt sampler (independent variable).

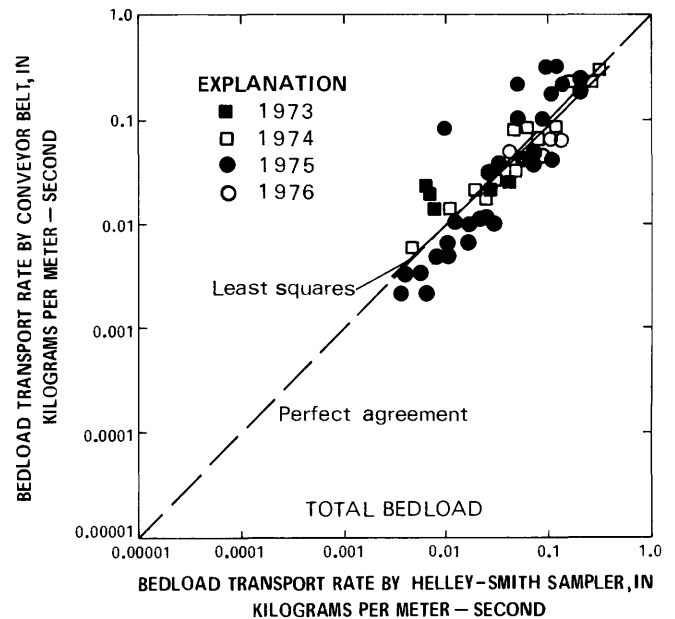

FIGURE 29.—Comparison of total bedload-transport rate; conveyor-belt sampler (dependent variable) versus Helley-Smith sampler (independent variable).

Modification (4) utilizes the data of modification (3) but reverses the independence of the axes as in modification (2). This yields a regression equation:

$$HS = 1.59 CB^{1.10}, \quad (4)$$

and retains a mean sediment-trapping efficiency of 124 percent. This is illustrated in figure 31.

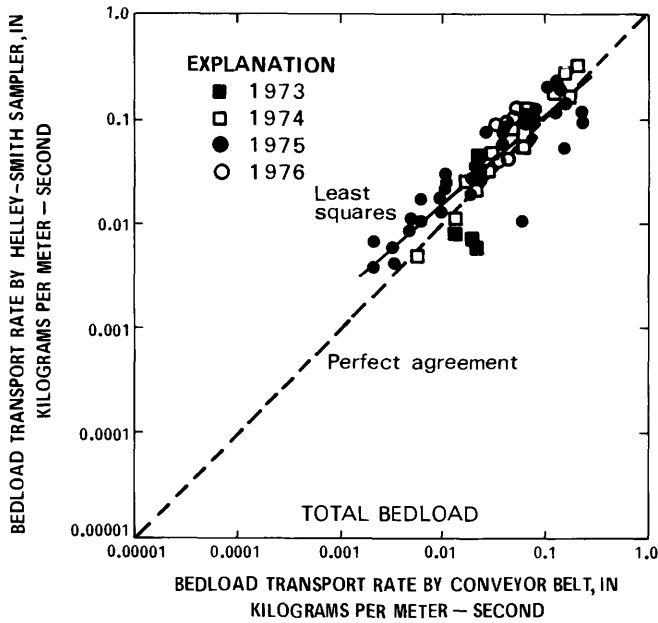

FIGURE 30.—Comparison of total bedload-transport rate; Helley-Smith sampler (dependent variable) versus conveyor-belt sampler corrected to condition of stream-wide slot (independent variable).

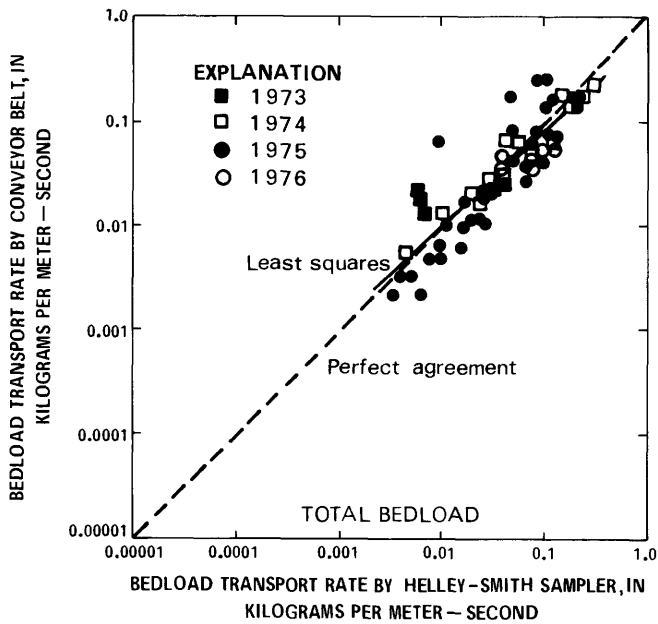

FIGURE 31.—Comparison of total bedload-transport rate; conveyor-belt sampler corrected to condition of stream-wide slot (dependent variable) versus Helley-Smith sampler (independent variable).

It was noted in an earlier section of this report that the mean river stage, or discharge, during the period of operating the Helley-Smith sampler was often, but only slightly, different than the mean discharge during the operation of the conveyor-belt sampler. Regression of the conveyor-belt-determined transport rates

against effective discharge (data of table 4) shows that bedload-transport rate is approximately proportional to the square of effective discharge. An appropriate correction factor to transpose the Helley-Smith transport data to the same hydraulic base as the conveyor-belt data would be

$$\left(\frac{Q'_{CB}}{Q'_{HS}} \right)^2$$

Values of this correction factor along with Helley-Smith-determined transport data, both unaltered and modified by the correction factor, are listed in table 10.

Modification (5) involves regressing corrected Helley-Smith data as just described against conveyor-belt data as modified in (3) above. The regression equation determined is

$$HS = 0.78 CB^{0.87} \tag{5}$$

and indicates a mean sediment-trapping efficiency of 123 percent. The graph of these results is shown in figure 32.

Reversal of the dependent and independent variables, as in modifications (2) and (4), shows some inadequacies of a least-squares statistical procedure in the analysis of some data sets. Use of least-squares techniques usually implies that data used as the independent variable are free of error. This is not the case with the present data, for, indeed, the data collected

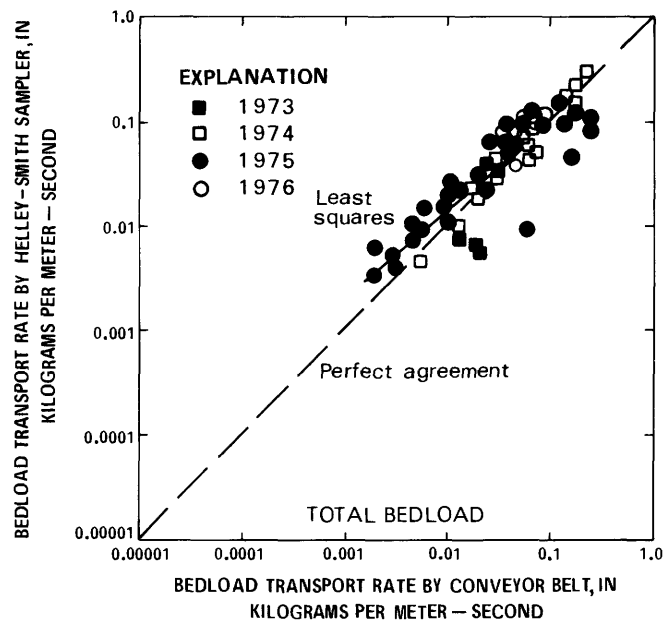

FIGURE 32.—Comparison of total bedload-transport rate; Helley-Smith sampler corrected for stage difference versus conveyor-belt sampler corrected for condition of stream-wide slot.

with the conveyor belt are subject to some of the same variability as are data collected with the Helley-Smith sampler. When the independent data have an error associated with them, the least-squares technique will invariably yield a relation which has underestimated the exponent or slope value of the relation. There does exist, however, a statistical procedure for adjusting slope value by a correction factor:

$$\left(1 + \frac{\sigma_i^2}{\sigma_x^2 - \sigma_i^2}\right),$$

where σ_i^2 is the variance of the error in the independent variable and σ_x^2 is the variance of the independent variable (see Snedecor and Cochran, 1967, p. 165).

Variance of the error in the conveyor-belt data can be obtained for those runs in which all gates were opened simultaneously and a minute-by-minute record was kept of the bedload-transport rate being measured. Necessary basic data for this determination can be found for conveyor-belt data collected in 1976 by reference to Leopold and Emmett (1977). Variance of the conveyor-belt data is obtained as part of the least-squares regression of the present analysis. A mean value of the least-squares correction factor, as obtained, is 1.069. This correction factor is based on measured total bedload; its uniform applicability to all particle-size classes is not known.

Modification (6) applies this correction factor to the regression of modification (5) and results in

$$HS = 0.96 CB^{0.93}, \quad (6)$$

and the mean sediment-trapping efficiency remains at 123 percent. This is graphed in figure 33.

It was earlier shown that collection of suspended sediment influences trap efficiency of small-size particles for the Helley-Smith sampler. Modification (7) uses the corrected conveyor-belt data of (2) but excludes sediment particles smaller than 0.25 mm. The resulting regression is

$$HS = 0.85 CB^{0.89} \quad (7)$$

and indicates a mean sediment-trapping efficiency of 123 percent. The graphic relation is shown in figure 34.

Modification (8) is identical to modification (7) except that it excludes all sediment particles smaller than 0.50 mm, the upper limit of particle sizes associated with suspended sediment. The new regression equation is

$$HS = 0.82 CB^{0.92}, \quad (8)$$

and a resulting mean sediment-trapping efficiency is 109 percent. The relation is graphed in figure 35.

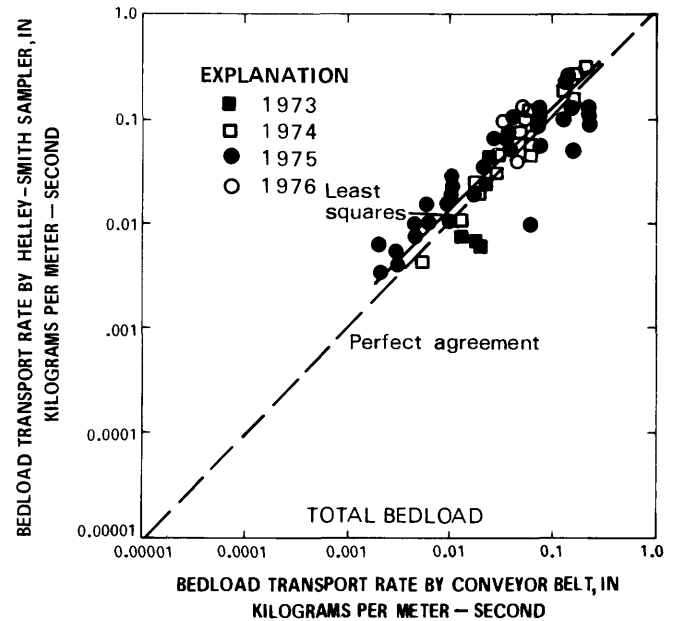

FIGURE 33.—Comparison of total bedload-transport rate; Helley-Smith sampler corrected for stage difference versus conveyor-belt sampler corrected for condition of stream-wide slot; relation corrected for variance of the independent variable in the least-squares regression.

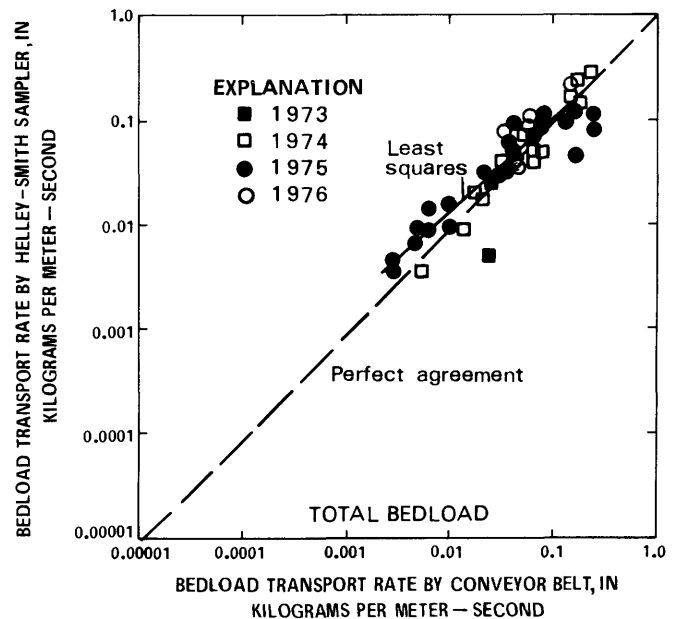

FIGURE 34.—Comparison of total bedload-transport rate for sediment particles larger than 0.25 mm; Helley-Smith sampler versus conveyor-belt sampler corrected for condition of stream-wide slot.

Modification (9) is similar to modification (8) except that it also includes correction for variance of the independent variable. The new result is

$$HS = 1.02 CB^{0.98}, \quad (9)$$

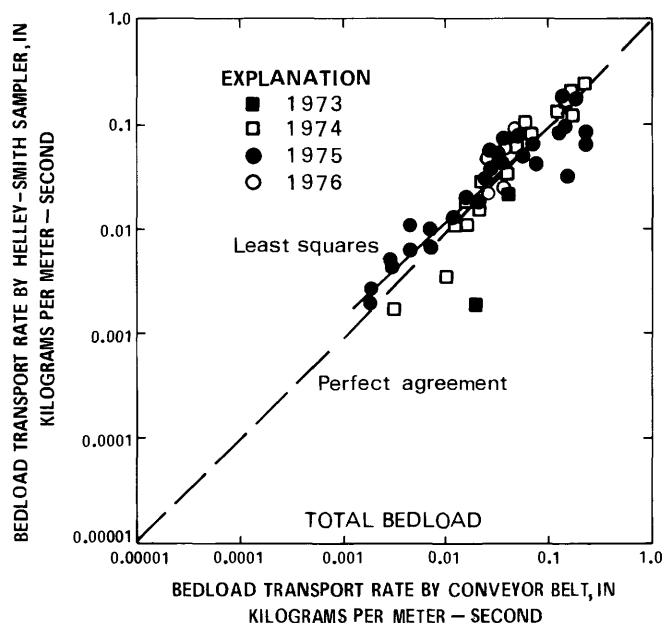

FIGURE 35.—Comparison of total bedload-transport rate for sediment particles larger than 0.50 mm; Helley-Smith sampler versus conveyor-belt sampler corrected for condition of stream-wide slot.

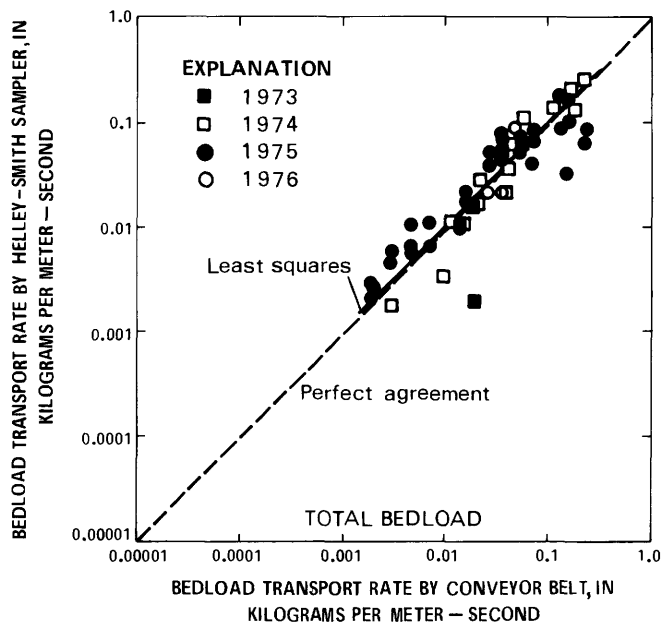

FIGURE 36.—Comparison of total bedload-transport rate for sediment particles larger than 0.50 mm; Helley-Smith sampler versus conveyor-belt sampler corrected for condition of stream-wide slot; relation corrected for variance of the independent variable in the least-squares regression.

and the mean trap efficiency remains at 109 percent. Figure 36 illustrates this regression.

Modification (10) involves regressing corrected Helley-Smith data against corrected conveyor-belt data (5) but also excludes sediment particles smaller than 0.25 mm. The relation determined is

$$HS = 0.87 CB^{0.90} \quad (10)$$

and includes a mean sediment-trapping efficiency of 122 percent. The relation is illustrated in figure 37.

Modification (11) is similar to (10) except that it excludes sediment particles smaller than 0.50 mm. The regression is

$$HS = 0.84 CB^{0.93} \quad (11)$$

and yields a mean sediment-trapping efficiency of 109 percent. This relation is illustrated in figure 38.

Modification (12) utilizes the regression of (11) and further includes correction for the variance of the independent variable. This regression yields a comparison of the Helley-Smith sampler to the conveyor-belt sampler of

$$HS = 1.05 CB^{0.99} \quad (12)$$

and gives a mean sediment-trapping efficiency of the Helley-Smith sampler of 109 percent. The relation is illustrated in figure 39.

The 12 modifications to the basic data give some regression equations that are quite different from some

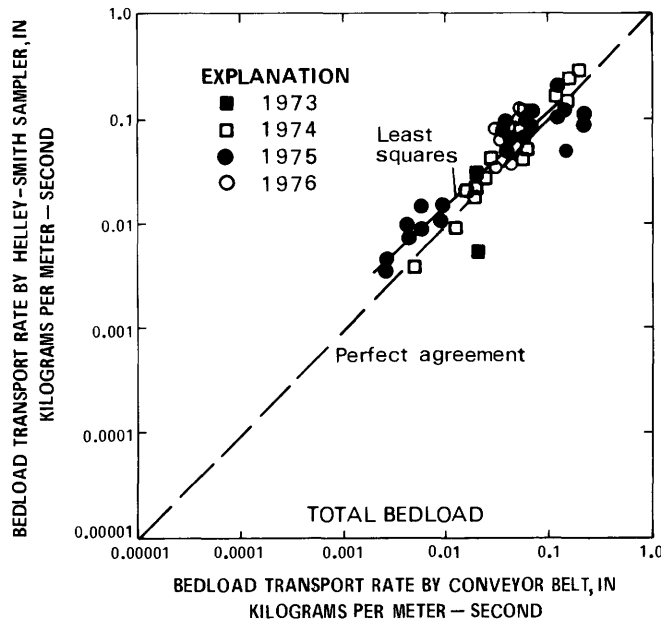

FIGURE 37.—Comparison of total bedload-transport rate for sediment particles larger than 0.25 mm; Helley-Smith sampler corrected for stage difference versus conveyor-belt sampler corrected for condition of stream-wide slot.

of the others, though reference to figures 28–39 indicates that throughout the measured range of transport rates, the variation is not as large as might be imagined. The real importance lies in extrapolation of relations some distance from the range of measured data,

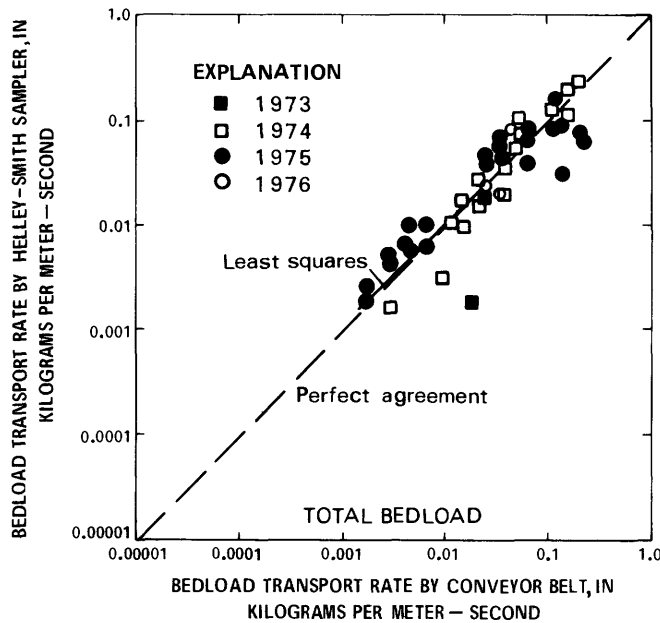

FIGURE 38.—Comparison of total bedload-transport rate for sediment particles larger than 0.50 mm; Helley-Smith sampler corrected for stage difference versus conveyor-belt sampler corrected for condition of stream-wide slot.

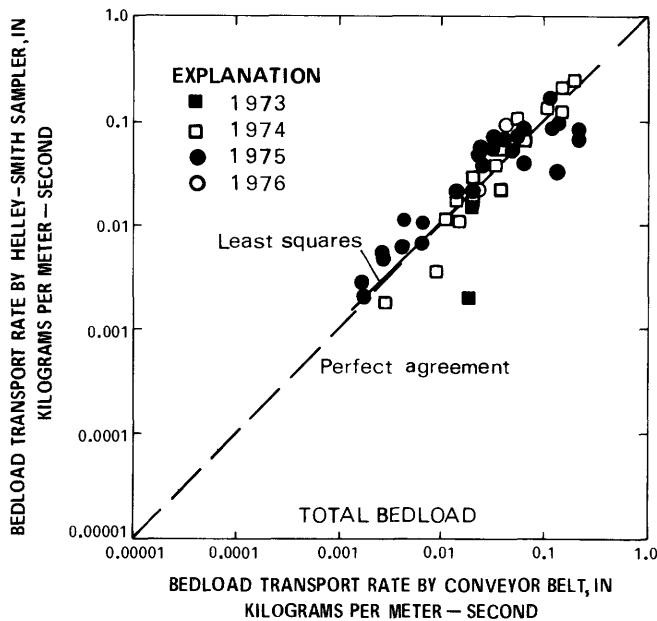

FIGURE 39.—Comparison of total bedload-transport rate for sediment particles greater than 0.50 mm; Helley-Smith sampler corrected for stage difference versus conveyor-belt sampler corrected for condition of stream-wide slot; relation corrected for variance of the independent variable in the least-squares regression.

because the difference in relations (1) to (12) generally increases in significance as the transport rate increases or decreases from the mean transport rate as determined in the study. It becomes a decision as to which

modifications to the basic data should be employed, and the reasoning for their use.

The writer believes all of the modifications are objective and relevant, but, lest a reader disagrees, this is the reason the basic data are presented first. Though all of the modifications may be relevant, it is apparent in the comparison of equations (5) to (3), (10) to (7), and (11) to (8) that the effect of correcting the Helley-Smith results to accommodate the slight differences in river stage is very modest and may be neglected. The correction for excluding suspended-sediment size particles (<0.50 mm) has no bearing on a comparison of the two methods of sampling on a particle-size class basis, when particle sizes are greater than 0.50 mm. Thus these two corrections need not be further considered.

The correction for error in the independent variable affects slope value of the relation only; it does not influence the value of mean sediment-trapping efficiency. It is not known with certainty if the slope correction factor can be applied equally to all particle-size classes; it thus becomes subjective in its application. This dilemma may be solved by not using the correction factor, utilizing mean sediment-trapping efficiency as determined, and recognizing that the rate of change in trap efficiency (exponent value of the regression equation) should be increased by an amount less than 10 percent of its value.

This leaves only the correction applied to some of the conveyor-belt data (table 10) to normalize these data to the condition of a continuous stream-wide open slot. Utilizing only this modification to the data, table 13 lists a summary of the statistical data generated when regressing the Helley-Smith sampler data against the conveyor-belt sampler data on a particle-size class basis. Graphings of data and least-squares relations are shown in figures 40-48.

A summary of the pertinent statistics from table 13 are listed below.

Particle-size class (mm)	Mean ratio in transport rate Helley-Smith:conveyor-belt (\bar{Y}/\bar{X} , in percent)	Rate of change in ratio of transport (B)
0.06- 0.12	143.03	1.030
.12- .25	246.00	.868
.25- .50	174.34	.914
.50- 1.00	114.74	1.016
1.00- 2.00	103.88	.923
2.00- 4.00	100.47	.848
4.00- 8.00	109.06	.775
8.00-16.00	109.04	.788
16.00-32.00	72.38	.501

Information on particle-size classes 0.06 to 0.12 mm and 0.12 to 0.25 mm is discarded. These are particle sizes nominally in suspension; further, the mesh collection bag for the Helley-Smith sampler cannot accommodate these sizes of sediment.

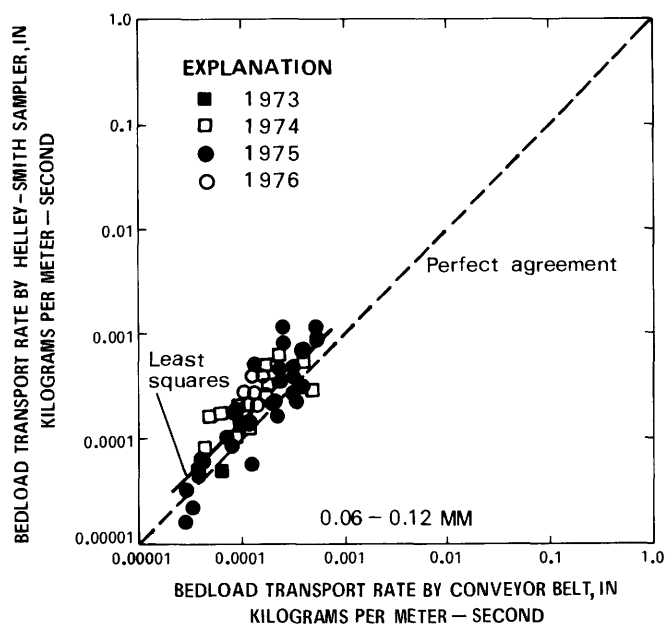

FIGURE 40.—Comparison of bedload-transport rate by individual particle-size category, Helley-Smith sampler versus conveyor-belt sampler corrected for condition of stream-wide slot; 0.06-0.12 mm size class.

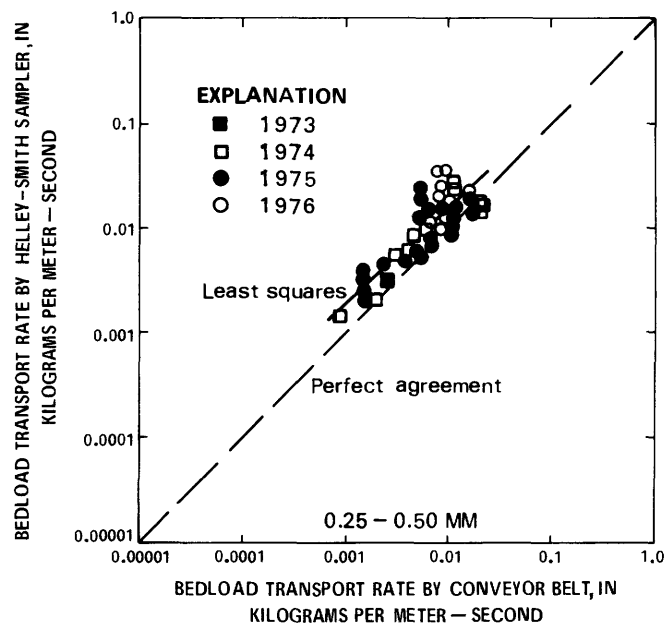

FIGURE 42.—Comparison of bedload-transport rate by individual particle-size category, Helley-Smith sampler versus conveyor-belt sampler corrected for condition of stream-wide slot; 0.25-0.50 mm size class.

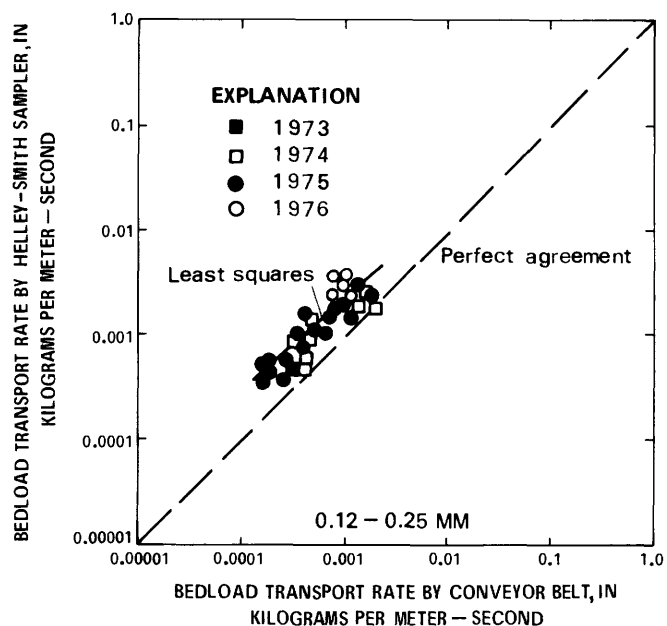

FIGURE 41.—Comparison of bedload-transport rate by individual particle-size category, Helley-Smith sampler versus conveyor-belt sampler corrected for condition of stream-wide slot; 0.12-0.25 mm size class.

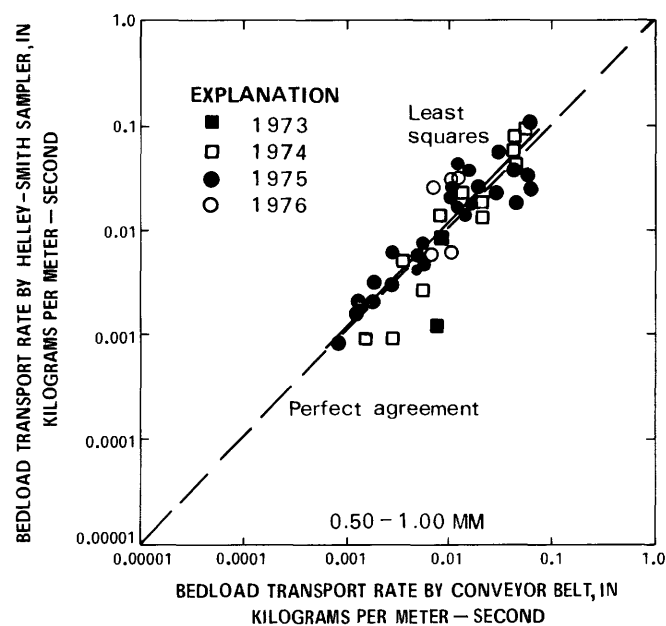

FIGURE 43.—Comparison of bedload-transport rate by individual particle-size category, Helley-Smith sampler versus conveyor-belt sampler corrected for condition of stream-wide slot; 0.50-1.00 mm size class.

For sediment in the particle-size class of 0.25 to 0.50 mm, the Helley-Smith sampler has a sediment-trapping efficiency of about 175 percent. Much of this overregistration is due to collection of suspended sediment, but no separate quantification can be made of the bedload sediment-trapping efficiency. The particu-

lar value of 175 percent is related to the proportion of bedload to suspended load in this particle-size class and may be a number unique to hydraulic and sediment characteristics of the East Fork River. It is not unreasonable, though purely speculative, that sediment-trapping efficiency for this particle-size class may be

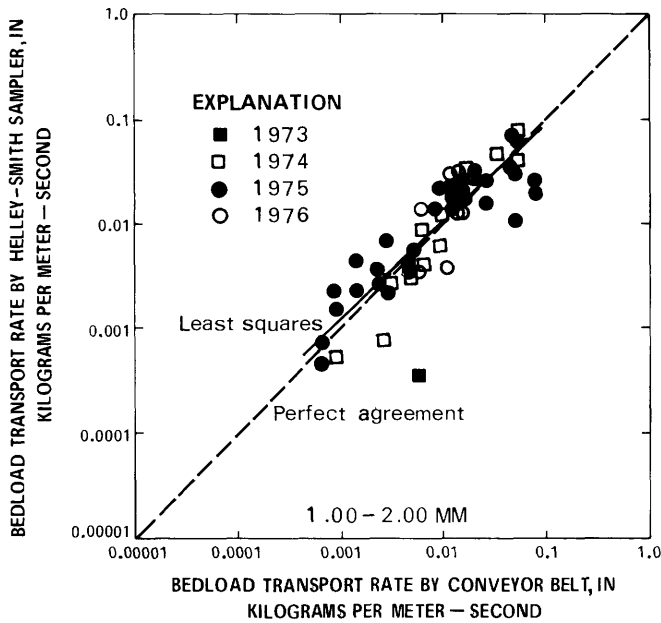

FIGURE 44.—Comparison of bedload-transport rate by individual particle-size category, Helley-Smith sampler versus conveyor-belt sampler corrected for condition of stream-wide slot; 1.00-2.00 mm size class.

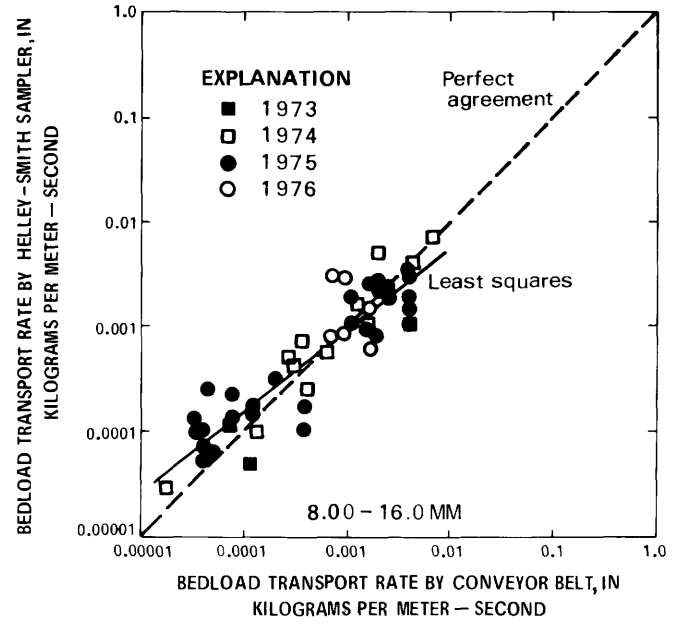

FIGURE 46.—Comparison of bedload-transport rate by individual particle-size category, Helley-Smith sampler versus conveyor-belt sampler corrected for condition of stream-wide slot; 4.00-8.00 mm size class.

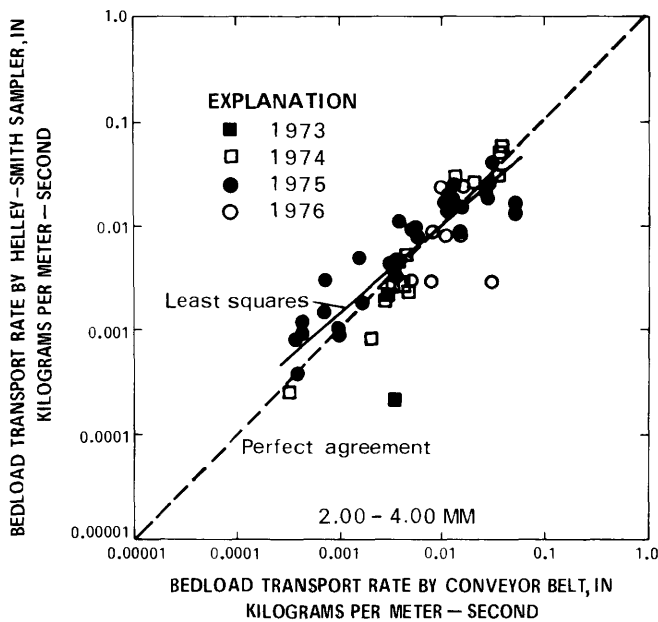

FIGURE 45.—Comparison of bedload-transport rate by individual particle-size category, Helley-Smith sampler versus conveyor-belt sampler corrected for condition of stream-wide slot; 2.00-4.00 mm size class.

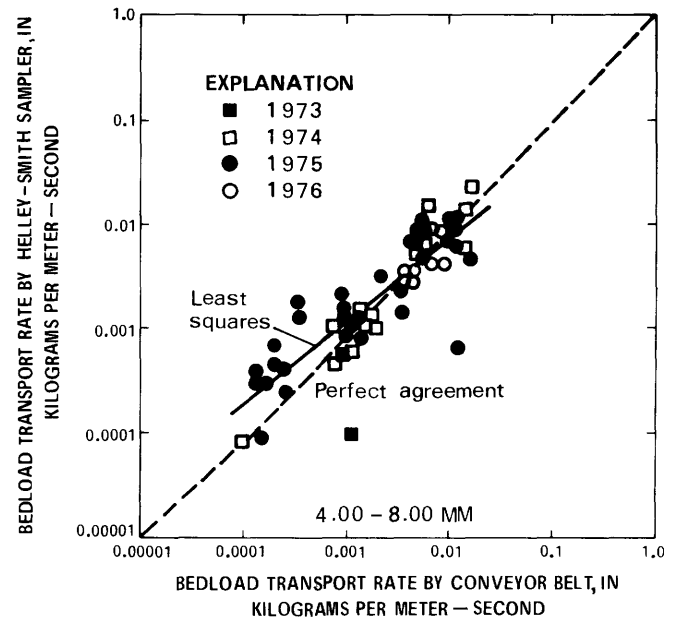

FIGURE 47.—Comparison of bedload-transport rate by individual particle-size category, Helley-Smith sampler versus conveyor-belt sampler corrected for condition of stream-wide slot; 8.00-16.0 mm size class.

near ideal for conditions involving no suspended-sediment transport.

For particle-size classes between 0.50 mm and about 16 mm, there is good agreement between the transport rate measured with the Helley-Smith sampler and that measured with the conveyor-belt sampler. Exponent

values of the regression equations indicate that trap efficiency of the Helley-Smith sampler decreases somewhat as transport rate increases, but correction for the error in the independent variable makes the actual decrease less than the apparent decrease in trap efficiency. Considering all factors involved in the ex-

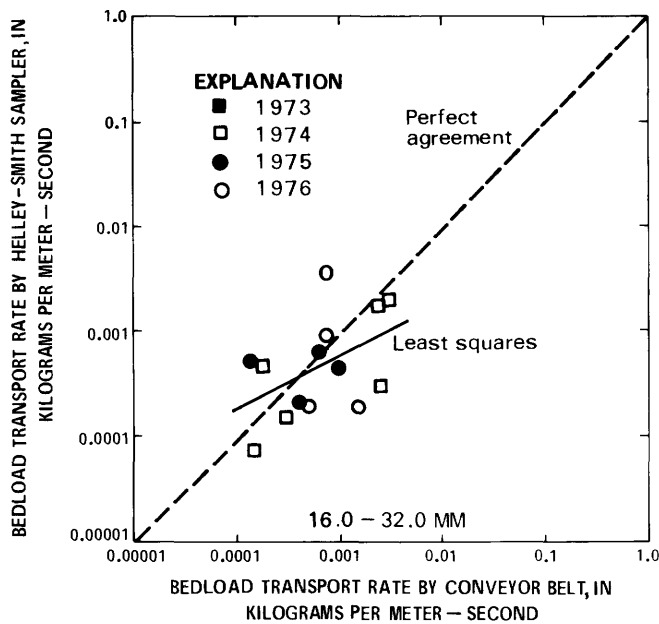

FIGURE 48.—Comparison of bedload-transport rate by individual particle-size category, Helley-Smith sampler versus conveyor-belt sampler corrected for condition of stream-wide slot; 16.0–32.0 mm size class.

perimental arrangement, the Helley-Smith bedload sampler may be considered as perfect a bedload sampler for these sizes of particles as is the conveyor-belt apparatus.

For particle sizes greater than about 16 mm, the Helley-Smith bedload sampler yields an apparent low sediment-trapping efficiency. This low trap efficiency is related to the paucity of large particles moving as bedload in the calibration stream and does not necessarily reflect an actual low trap efficiency for large particles.

SUMMARY AND RECOMMENDATIONS

The sediment-trapping characteristics of the Helley-Smith bedload sampler were studied by comparing sediment-transport rates as measured with the Helley-Smith sampler with those measured utilizing an open slot constructed across a streambed. The number of data sets used in the comparison is large, and range in measured transport rates is nearly 1,000-fold.

Unaltered basic data indicate the Helley-Smith bedload sampler, for the majority of sediment sizes available in the study, is 90 to 100 percent efficient, but efficiency decreases somewhat with increases in transport rate. Modifications of the basic data to normalize the data sets and correct for statistical procedures indicate trap efficiency is 100 to 110 percent and varies little with changes in transport rate.

Based on all analyses of this report, the following recommendations are made relative to the sediment-trapping characteristics of the Helley-Smith bedload sampler:

- (1) The Helley-Smith bedload sampler should not be used for sediment particles smaller than 0.25 mm.
- (2) The Helley-Smith bedload sampler should not be used for measuring bedload-transport rates for sediment of particle sizes which also are transported as suspended sediment.
- (3) The trap efficiency for sediment in the particle-size class of 0.25 to 0.50 mm was indeterminate, being 175 percent in the test stream; 100 percent is recommended for the condition of no suspended-sediment transport.
- (4) For sediment of particle-sizes larger than 0.50 mm and smaller than 16 mm, sediment-trapping efficiency of the Helley-Smith bedload sampler may be assumed as 100 percent, with no change in efficiency with changes in transport rate.
- (5) Trap efficiency for sediment particles larger than 16 mm was indeterminate, being about 70 percent in the test stream; reduction in efficiency was related to the small number of large particles moving; actual efficiency may increase with an increase in the transport rate of particles larger than 16 mm. Obviously, trap efficiency goes to zero when particle size exceeds nozzle opening; no data are available to define trap efficiency as particle sizes approach nozzle dimensions.

ACKNOWLEDGMENTS

In addition to principal assistance in project activities that have been noted previously in appropriate sections of the text, I would like to thank Steve Parsons for the laborious task of sieving the samples; Holly Mahoney, Shirley Stewart, and Brent Troutman for assistance in data analysis and manuscript preparation; and Verne Schneider, William Curtis, Tom Lisle, Paul Benedict, Michael Foley, and especially M. deVries for their review of the draft manuscript. The field site is located on the property of Howard Routh. Henry Yake, Harvey Taylor, and Wilfrid Edwards are local businessmen who provided services and materials essential to successful maintenance of the research installation.

REFERENCES CITED

- Andrews, E. D., 1977, Hydraulic adjustment of an alluvial stream channel to the supply of sediment, and, scour and fill in an alluvial stream channel: Unpublished Ph.D. dissertation, University of California, Berkeley, California, 152 p.
- Draper, H. R., and Smith, H., 1966, Applied Regression Analysis: New York, John Wiley and Sons, Inc., 407 p.

- Druffell, L., Emmett, W. W., Schneider, V. R., and Skinner, J. V., 1976, Laboratory calibration of the Helley-Smith bedload sediment sampler: U.S. Geological Survey Open-File Report 76-752, 63 p.
- DHL, 1969, Calibration of bedload transport samplers (in Dutch): Delft Hydraulics Laboratory report M601-III.
- Hamamori, A., 1962, A theoretical investigation on the fluctuation of bedload transport: Delft Hydraulics Laboratory report R4.
- Helley, E. J., and Smith, W., 1971, Development and calibration of a pressure-difference bedload sampler: U.S. Geological Survey open-file report, 18 p.
- Hubbell, D. W., 1964, Apparatus and techniques for measuring bedload: U.S. Geological Survey Water-Supply Paper 1748, 74 p.
- Leopold, L. B., and Emmett, W. W., 1976, Bedload measurements, East Fork River, Wyoming: National Academy of Science Proceedings, v. 73, no. 4, p. 1000-1004.
- 1977, 1976 bedload measurements, East Fork River, Wyoming: National Academy of Science Proceedings, v. 74, no. 7, p. 2644-2648.
- Lisle, T. E., 1976, Components of flow resistance in a natural channel: Unpublished Ph.D. dissertation, University of California, Berkeley, California, 60 p.
- Mahoney, H. A., Andrews, E. D., Emmett, W. W., Leopold, L. B., Meade, R. H., Myrick, R. M., and Nordin, C. F., 1976, Data for calibrating unsteady-flow sediment-transport models, East Fork River, Wyoming, 1975: U.S. Geological Survey Open-File Report 76-22, 293 p.
- Schoklitsch, A., 1950, Handbuch des Wasserbaues [2nd ed.]: Springer, Vienna, English translation by S. Shulits.
- Snedecor, G. W., and Cochran, W. G., 1967, Statistical Methods: Ames, Iowa State University Press, 593 p.

TABLES 4-13

TABLE 4.—Summary data of river hydraulics and bedload transport, conveyor-belt sampler

Date ¹	River discharge		Mean depth, ⁴ <i>D</i> (m)	Mean velocity, ⁵ <i>V</i> (m/s)	Unit bedload-transport rate, ⁶ <i>J_b</i> (kg/m-s)	Bedload size, ⁷ <i>d₅₀</i> (mm)
	Total, ² <i>Q</i> (m ³ /s)	Effective, ³ <i>Q'</i> (m ³ /s)				
5-26-73	17.0	16.1	1.04	1.06	0.0122	1.35
5-28-73	6.66	6.50	.55	.81	.0009	-----
5-29-73	7.50	7.30	.59	.84	.0011	-----
6-01-73	17.0	16.1	1.04	1.06	.0190	-----
6-02-73	18.8	17.8	1.11	1.09	.0235	.74
6-03-73	17.5	16.6	1.06	1.07	.0240	-----
6-06-73	11.8	11.3	.81	.96	.0133	-----
6-07-73	16.7	15.9	1.03	1.06	.0260	-----
6-08-73	20.3	19.2	1.17	1.19	.0218	.98
5-25-74	5.44	5.34	.48	.76	.0056	.54
5-26-74	10.3	9.92	.74	.92	.0822	.59
5-27-74	22.9	21.5	1.27	1.15	.1758	1.03
5-28-74	32.0	29.8	1.60	1.28	.2255	1.40
5-29-74	45.0	41.5	2.01	1.41	.2912	1.52
5-30-74	34.6	32.2	1.68	1.31	.0786	1.51
5-31-74	24.4	22.9	1.33	1.18	.0647	1.40
6-01-74	25.9	24.3	1.38	1.20	.0206	.94
6-02-74	27.2	25.5	1.43	1.22	.0130	.99
6-03-74	31.9	29.7	1.59	1.27	.0172	.88
6-04-74	29.9	27.9	1.52	1.25	.0285	.92
6-05-74	28.3	26.5	1.47	1.23	.0305	.81
5-27-75	2.44	2.44	.28	.61	.0021	-----
5-30-75	2.04	2.04	.24	.57	.0016	-----
6-02-75	5.98	5.82	.51	.78	.0484	.74
6-03-75	9.52	9.13	.70	.90	.0791	-----
6-04-75	10.5	10.0	.74	.92	.0812	1.16
6-05-75	11.2	10.7	.78	.94	.0972	1.26
6-06-75	21.3	20.0	1.21	1.13	.3114	1.36
6-07-75	26.6	24.8	1.40	1.21	.2069	1.28
6-08-75	27.5	25.6	1.44	1.22	.1733	1.41
6-09-75	26.2	24.3	1.38	1.20	.0833	1.35
6-10-75	15.3	14.4	.96	1.03	.0348	-----
6-11-75	10.6	10.1	.75	.92	.0110	-----
6-13-75	16.7	15.8	1.02	1.06	.0277	.50
6-14-75	27.6	25.7	1.44	1.22	.0926	1.27
6-15-75	31.4	29.0	1.57	1.27	.1190	1.05
6-16-75	32.8	30.3	1.62	1.28	.1190	1.19
6-17-75	23.8	22.2	1.30	1.17	.0796	1.36
6-18-75	13.5	12.8	.88	.99	.0106	-----
6-19-75	10.5	10.1	.75	.92	.0097	.73
6-21-75	7.48	7.23	.59	.84	.0032	.70
6-22-75	7.25	7.01	.58	.83	.0047	.64
6-23-75	8.55	8.24	.65	.87	.0062	.77
6-24-75	11.3	10.8	.78	.94	.0194	.98
6-25-75	23.2	21.7	1.28	1.16	.0838	1.10
6-26-75	13.8	13.1	.90	1.00	.0396	.99
7-01-75	24.8	23.1	1.34	1.18	.2159	1.63
7-08-75	23.0	21.5	1.27	1.16	.0317	.91
5-18-76	10.4	9.87	.78	.87	.0838	.98
5-19-76	15.7	14.8	1.01	1.00	.1359	1.04
5-20-76	20.3	18.9	1.19	1.09	.1163	.96
5-20-76	21.0	19.6	1.22	1.10	.1295	1.04
5-21-76	24.0	22.4	1.33	1.15	.1769	1.52
5-22-76	18.6	17.5	1.13	1.06	.0754	1.56
5-26-76	10.3	9.77	.77	.87	.0130	.71

TABLE 4.—Summary data of river hydraulics and bedload transport, conveyor-belt sampler—Continued

Date ¹	River discharge		Mean depth, ¹ <i>D</i> (m)	Mean velocity, ⁵ <i>V</i> (m/s)	Unit bedload-transport rate, ⁶ <i>j_b</i> (kg/m-s)	Bedload size, ⁷ <i>d₅₀</i> (mm)
	Total, ² <i>Q</i> (m ³ /s)	Effective, ³ <i>Q'</i> (m ³ /s)				
5-27-76	15.2	14.3	.99	.99	.0232	.59
5-27-76	14.5	13.7	.96	.97	.0301	.61
5-27-76	13.8	13.0	.93	.96	.0233	.77
5-28-76	20.1	18.8	1.18	1.08	.0437	.95
5-28-76	21.2	19.8	1.23	1.10	.0454	1.11
5-29-76	22.0	20.5	1.25	1.12	.0712	1.30
5-29-76	22.4	20.9	1.27	1.12	.0618	1.67
5-30-76	22.4	20.9	1.27	1.12	.0774	1.29
5-31-76	17.7	16.6	1.09	1.04	.0621	1.09
5-31-76	16.8	15.8	1.06	1.02	.0405	.98
6-01-76	15.2	14.3	.99	.99	.0361	.81
6-01-76	14.7	13.9	.97	.98	.0325	.80
6-02-76	19.1	17.9	1.15	1.07	.0576	.94
6-02-76	19.0	17.8	1.14	1.06	.0463	1.04
6-03-76	23.2	21.6	1.30	1.14	.0834	1.18
6-04-76	23.4	21.8	1.30	1.14	.0871	1.40
6-05-76	23.0	21.4	1.29	1.13	.0918	1.76
6-05-76	24.0	22.4	1.33	1.15	.0784	1.51
6-06-76	24.2	22.6	1.33	1.16	.0908	1.30
6-07-76	26.5	24.6	1.41	1.19	.0869	1.35
6-08-76	22.7	21.1	1.28	1.13	.0570	1.24
6-09-76	20.1	18.8	1.18	1.08	.0513	1.03
6-09-76	20.3	18.9	1.19	1.09	.0346	1.08
6-10-76	19.5	18.2	1.16	1.07	.0290	1.06
6-11-76	14.6	13.8	.97	.98	.0253	.84
6-11-76	15.4	14.5	1.00	.99	.0289	1.05
6-11-76	16.6	15.7	1.05	1.02	.0280	1.02
6-11-76	16.1	15.2	1.03	1.01	.0629	1.07
6-11-76	15.3	14.4	.99	.99	.0236	.79
6-12-76	13.9	13.1	.93	.96	.0181	.81
6-12-76	13.2	12.5	.90	.94	.0169	.77
6-12-76	11.8	11.2	.84	.91	.0162	.81
6-12-76	11.0	10.5	.81	.89	.0145	.82
6-12-76	10.1	9.64	.76	.86	.0106	.82
6-12-76	8.89	8.50	.70	.83	.0084	.77
6-13-76	6.80	6.55	.59	.76	.0028	.49
6-14-76	5.13	4.97	.50	.69	.0022	.41
6-14-76	4.79	4.65	.47	.67	.0020	.53
6-15-76	3.96	3.87	.42	.64	.0003	.66
6-15-76	3.51	3.44	.39	.61	.0004	.88
6-16-76	5.13	4.97	.50	.69	.0009	.50
6-18-76	3.99	3.90	.42	.63	.0006	.42
6-19-76	4.30	4.20	.44	.65	.0009	.44
6-20-76	4.70	4.57	.47	.67	.0023	.43
6-21-76	10.0	9.53	.76	.86	.0181	.68

¹Dates correspond to dates listed in table 5.

²Complete river discharge including overbank flow.

³Discharge over 14.6-m width of bedload trap; includes all flow over the active width of the streambed.

⁴Mean depth over effective width W : $D = \frac{Q'}{VW}$.

⁵Mean velocity of effective discharge: $V = \frac{Q'}{WD} = \frac{Q'}{14.6D}$.

⁶Unit transport rate of solids in dry weight per second, over 14.6-m width of bedload trap.

⁷ d_{50} is median diameter of grains; complete grain-size data are given in table 5.

TABLE 5.—Particle-size distribution of bedload sediment, conveyor-belt sampler

Date ¹ ----	5-26-73	5-28-73	5-29-73	6-01-73	6-02-73	6-03-73	6-06-73	6-07-73	6-08-73	5-25-74	5-26-74	5-27-74	5-28-74	5-29-74
Q ₂ ² -----	16.1	6.50	7.30	16.1	17.8	16.6	11.3	15.9	19.2	5.34	9.92	21.5	29.8	41.5
J _s ³ -----	0.0122	0.0009	0.0011	0.0190	0.0235	0.0240	0.0133	0.0260	0.0218	0.0056	0.0822	0.1758	0.2255	0.2912

Percent by weight finer than sieve size (mm) indicated

0.06 -----	0.1	(⁴)	(⁴)	(⁴)	0.3	(⁴)	(⁴)	(⁴)	0.1	0.3	0.2	-----	-----	-----
0.09 -----	.3	(⁴)	(⁴)	(⁴)	.4	(⁴)	(⁴)	(⁴)	.3	.5	.5	0.1	-----	0.1
0.12 -----	.4	(⁴)	(⁴)	(⁴)	.7	(⁴)	(⁴)	(⁴)	.4	1.1	1.0	.3	0.1	.1
0.18 -----	7	(⁴)	(⁴)	(⁴)	1.3	(⁴)	(⁴)	(⁴)	1.0	2.8	2.1	.6	.1	.3
0.25 -----	1.3	(⁴)	(⁴)	(⁴)	2.6	(⁴)	(⁴)	(⁴)	1.9	8.9	4.3	1.4	.5	.5
0.35 -----	3.7	(⁴)	(⁴)	(⁴)	7.4	(⁴)	(⁴)	(⁴)	4.8	27.0	13.0	4.6	1.9	1.4
0.50 -----	9.9	(⁴)	(⁴)	(⁴)	22.1	(⁴)	(⁴)	(⁴)	13.8	46.2	38.3	15.6	6.9	5.6
0.71 -----	22.1	(⁴)	(⁴)	(⁴)	48.2	(⁴)	(⁴)	(⁴)	34.0	63.8	62.6	32.4	18.8	17.3
1.00 -----	36.8	(⁴)	(⁴)	(⁴)	62.6	(⁴)	(⁴)	(⁴)	51.2	75.9	75.3	48.8	34.1	33.5
1.41 -----	52.0	(⁴)	(⁴)	(⁴)	73.0	(⁴)	(⁴)	(⁴)	65.6	85.1	83.5	62.3	50.4	47.4
2.00 -----	67.6	(⁴)	(⁴)	(⁴)	83.3	(⁴)	(⁴)	(⁴)	77.9	92.3	90.8	75.7	66.8	59.4
2.83 -----	80.0	(⁴)	(⁴)	(⁴)	90.9	(⁴)	(⁴)	(⁴)	87.9	96.1	95.8	85.5	78.8	69.0
4.00 -----	88.8	(⁴)	(⁴)	(⁴)	96.2	(⁴)	(⁴)	(⁴)	94.9	98.2	98.7	92.2	88.2	76.5
5.66 -----	95.7	(⁴)	(⁴)	(⁴)	98.4	(⁴)	(⁴)	(⁴)	98.1	99.2	99.5	95.1	93.2	81.0
8.00 -----	98.2	(⁴)	(⁴)	(⁴)	99.7	(⁴)	(⁴)	(⁴)	99.5	99.7	99.8	96.5	96.1	83.6
11.3 -----	99.4	(⁴)	(⁴)	(⁴)	100.0	(⁴)	(⁴)	(⁴)	100.0	100.0	100.0	97.2	97.7	85.7
16.0 -----	100.0	(⁴)	(⁴)	(⁴)	-----	(⁴)	(⁴)	(⁴)	-----	-----	-----	97.7	98.5	86.5
22.6 -----	-----	(⁴)	(⁴)	(⁴)	-----	(⁴)	(⁴)	(⁴)	-----	-----	-----	98.2	99.4	87.5
32.0 -----	-----	(⁴)	(⁴)	(⁴)	-----	(⁴)	(⁴)	(⁴)	-----	-----	-----	100.0	100.0	87.9
45.0 -----	-----	(⁴)	(⁴)	(⁴)	-----	(⁴)	(⁴)	(⁴)	-----	-----	-----	-----	-----	89.2
64.0 -----	-----	(⁴)	(⁴)	(⁴)	-----	(⁴)	(⁴)	(⁴)	-----	-----	-----	-----	-----	100.0

Particle size (mm) at given percent finer

d ₅ -----	0.39	(⁴)	(⁴)	(⁴)	0.31	(⁴)	(⁴)	(⁴)	0.36	0.21	0.26	0.36	0.45	0.48
d ₁₆ -----	.61	(⁴)	(⁴)	(⁴)	.44	(⁴)	(⁴)	(⁴)	.52	.29	.37	.50	.66	.69
d ₃₅ -----	.96	(⁴)	(⁴)	(⁴)	.60	(⁴)	(⁴)	(⁴)	.72	.41	.48	.75	1.02	1.04
d ₅₀ -----	1.35	(⁴)	(⁴)	(⁴)	.74	(⁴)	(⁴)	(⁴)	.98	.54	.59	1.03	1.40	1.52
d ₆₅ -----	1.88	(⁴)	(⁴)	(⁴)	1.08	(⁴)	(⁴)	(⁴)	1.39	.73	.75	1.51	1.92	2.44
d ₈₄ -----	3.27	(⁴)	(⁴)	(⁴)	2.06	(⁴)	(⁴)	(⁴)	2.44	1.36	1.45	2.67	3.39	8.71
d ₉₅ -----	5.38	(⁴)	(⁴)	(⁴)	3.61	(⁴)	(⁴)	(⁴)	4.03	2.51	2.63	5.57	6.89	48.9

Date ¹ ----	5-30-74	5-31-74	6-01-74	6-02-74	6-03-74	6-04-74	6-05-74	5-27-75	5-30-75	6-02-75	6-03-75	6-04-75	6-05-75	6-06-75
Q ₂ ² -----	32.2	22.9	24.3	25.5	29.7	27.9	26.5	2.44	2.04	5.82	9.13	10.0	10.7	20.0
J _s ³ -----	0.0786	0.0647	0.0206	0.0130	0.0172	0.0285	0.0305	0.0021	0.0016	0.0484	0.0791	0.0812	0.0972	0.3114

Percent by weight finer than sieve size (mm) indicated

0.06 -----	0.1	-----	0.1	0.2	0.1	0.1	0.2	(⁴)	(⁴)	0.5	(⁴)	0.2	0.2	0.2
0.09 -----	1	-----	.2	.4	.3	.2	.4	(⁴)	(⁴)	.7	(⁴)	.3	.3	.2
0.12 -----	.3	0.1	.4	.9	.6	.4	.6	(⁴)	(⁴)	1.1	(⁴)	.5	.4	.3
0.18 -----	.6	.3	.8	1.5	1.2	.8	1.0	(⁴)	(⁴)	1.9	(⁴)	.8	.6	.4
0.25 -----	1.2	1.1	2.5	3.5	3.2	1.9	2.2	(⁴)	(⁴)	4.3	(⁴)	1.6	1.0	.8
0.35 -----	2.6	4.0	9.8	11.5	14.0	8.5	10.0	(⁴)	(⁴)	14.2	(⁴)	4.8	3.2	2.3
0.50 -----	7.6	10.0	23.3	26.1	31.0	23.3	30.1	(⁴)	(⁴)	30.8	(⁴)	14.4	10.4	8.2
0.71 -----	18.2	22.3	37.2	38.5	43.3	38.8	45.0	(⁴)	(⁴)	48.1	(⁴)	29.1	24.2	21.9
1.00 -----	32.3	36.4	52.6	50.4	54.2	53.4	58.3	(⁴)	(⁴)	60.8	(⁴)	43.1	38.6	36.1
1.41 -----	47.1	49.6	65.3	60.7	63.7	65.8	69.3	(⁴)	(⁴)	73.7	(⁴)	59.0	55.5	51.7
2.00 -----	63.0	64.2	77.3	71.1	73.3	77.4	80.0	(⁴)	(⁴)	85.7	(⁴)	76.7	73.5	69.3
2.83 -----	76.3	77.3	86.1	80.4	81.9	85.7	87.9	(⁴)	(⁴)	92.2	(⁴)	89.4	86.9	82.6
4.00 -----	86.4	88.0	92.5	88.0	90.1	91.9	93.7	(⁴)	(⁴)	96.5	(⁴)	96.5	95.4	91.6
5.66 -----	92.6	93.5	96.5	92.8	95.0	95.7	96.9	(⁴)	(⁴)	99.0	(⁴)	98.6	98.6	95.8
8.00 -----	96.5	97.0	98.3	95.4	98.5	97.9	99.0	(⁴)	(⁴)	99.8	(⁴)	99.7	99.5	97.9
11.3 -----	98.3	98.7	99.4	97.6	100.0	99.6	100.0	(⁴)	(⁴)	100.0	(⁴)	99.8	99.8	98.8
16.0 -----	99.7	99.4	100.0	98.5	-----	100.0	-----	(⁴)	(⁴)	-----	(⁴)	100.0	100.0	99.6
22.6 -----	100.0	100.0	-----	100.0	-----	-----	-----	(⁴)	(⁴)	-----	(⁴)	-----	-----	100.0
32.0 -----	-----	-----	-----	-----	-----	-----	-----	(⁴)	(⁴)	-----	(⁴)	-----	-----	-----
45.0 -----	-----	-----	-----	-----	-----	-----	-----	(⁴)	(⁴)	-----	(⁴)	-----	-----	-----
64.0 -----	-----	-----	-----	-----	-----	-----	-----	(⁴)	(⁴)	-----	(⁴)	-----	-----	-----

Particle size (mm) at given percent finer

d ₅ -----	0.43	0.38	0.29	0.27	0.27	0.31	0.30	(⁴)	(⁴)	10.26	(⁴)	0.36	0.40	0.43
d ₁₆ -----	.67	.60	.42	.40	.37	.43	.40	(⁴)	(⁴)	.37	(⁴)	.52	.59	.62
d ₃₅ -----	1.07	.97	.67	.64	.56	.65	.56	(⁴)	(⁴)	.55	(⁴)	.82	.92	.98
d ₅₀ -----	1.51	1.40	.94	.99	.88	.92	.81	(⁴)	(⁴)	.74	(⁴)	1.16	1.26	1.36
d ₆₅ -----	2.10	2.04	1.40	1.62	1.48	1.38	1.23	(⁴)	(⁴)	1.11	(⁴)	1.58	1.68	1.83
d ₈₄ -----	3.66	3.47	2.59	3.31	3.07	2.63	2.36	(⁴)	(⁴)	1.90	(⁴)	2.40	2.60	2.97
d ₉₅ -----	6.83	6.40	8.84	7.52	5.66	5.23	4.50	(⁴)	(⁴)	3.45	(⁴)	3.61	3.90	5.21

TABLE 5.—Particle-size distribution of bedload sediment, conveyor-belt sampler—Continued

Date ¹	6-07-75	6-08-75	6-09-75	6-10-75	6-11-75	6-13-75	6-14-75	6-15-75	6-16-75	6-17-75	6-18-75	6-19-75	6-21-75	6-22-75
Q ²	24.8	25.6	24.3	14.4	10.1	15.8	25.7	29.0	30.3	22.2	12.8	10.1	7.23	7.01
b ³	0.2069	0.1733	0.0833	0.0348	0.0110	0.0277	0.0926	0.1190	0.1190	0.0796	0.0106	0.0097	0.0032	0.0047

Percent by weight finer than sieve size (mm) indicated

0.06	0.2	0.2	0.2	(⁴)	(⁴)	0.4	0.3	0.2	0.2	0.2	(⁴)	0.2	0.6	0.5
0.09	.3	.3	.3	(⁴)	(⁴)	.5	.4	.2	.3	.2	(⁴)	.4	.9	.6
0.12	.4	.5	.4	(⁴)	(⁴)	.8	.6	.4	.4	.2	(⁴)	.6	1.6	1.1
0.18	.5	.9	.6	(⁴)	(⁴)	1.7	.9	.6	.7	.3	(⁴)	1.2	2.9	2.4
0.25	.9	1.8	1.5	(⁴)	(⁴)	5.9	2.0	1.3	1.4	.9	(⁴)	3.5	7.0	7.0
0.35	2.3	4.0	4.7	(⁴)	(⁴)	28.7	5.7	5.5	5.1	4.5	(⁴)	16.6	20.6	22.9
0.50	8.1	8.4	9.8	(⁴)	(⁴)	50.2	14.4	13.8	14.0	11.8	(⁴)	30.0	35.0	39.0
0.71	22.9	19.5	21.5	(⁴)	(⁴)	68.2	27.8	30.4	28.2	24.0	(⁴)	48.9	50.2	54.9
1.00	38.8	32.9	36.0	(⁴)	(⁴)	77.7	40.8	47.8	43.9	36.9	(⁴)	63.1	63.8	68.6
1.41	54.8	50.0	52.1	(⁴)	(⁴)	84.6	54.3	62.0	56.2	51.8	(⁴)	76.4	74.7	78.7
2.00	70.8	68.0	68.2	(⁴)	(⁴)	90.8	68.0	74.7	69.3	68.4	(⁴)	87.4	83.7	86.7
2.83	82.3	81.6	80.8	(⁴)	(⁴)	95.5	79.6	84.4	80.5	81.2	(⁴)	93.8	90.5	92.2
4.00	90.4	91.0	89.6	(⁴)	(⁴)	98.6	88.3	91.8	89.7	90.7	(⁴)	97.3	95.4	96.2
5.66	94.5	95.4	94.2	(⁴)	(⁴)	99.6	93.6	94.9	94.2	95.8	(⁴)	98.9	97.3	98.1
8.00	97.1	98.0	97.3	(⁴)	(⁴)	100.0	96.8	97.3	97.1	98.2	(⁴)	99.6	99.0	99.0
11.3	98.6	99.2	98.9	(⁴)	(⁴)	-----	99.1	98.6	98.5	99.4	(⁴)	100.0	100.0	99.5
16.0	99.6	99.7	99.8	(⁴)	(⁴)	-----	99.7	99.5	99.3	100.0	(⁴)	-----	-----	100.0
22.6	100.0	100.0	100.0	(⁴)	(⁴)	-----	100.0	100.0	100.0	-----	(⁴)	-----	-----	-----
32.0	-----	-----	-----	(⁴)	(⁴)	-----	-----	-----	-----	-----	(⁴)	-----	-----	-----
45.0	-----	-----	-----	(⁴)	(⁴)	-----	-----	-----	-----	-----	(⁴)	-----	-----	-----
64.0	-----	-----	-----	(⁴)	(⁴)	-----	-----	-----	-----	-----	(⁴)	-----	-----	-----

Particle size (mm) at given percent finer

d ₅	0.43	0.39	0.36	(⁴)	(⁴)	0.24	0.34	0.34	0.35	0.37	(⁴)	0.27	0.22	0.22
d ₁₀	.62	.64	.61	(⁴)	(⁴)	.30	.52	.53	.53	.57	(⁴)	.35	.32	.31
d ₂₅	.93	1.05	.78	(⁴)	(⁴)	.39	.86	.78	.83	.95	(⁴)	.55	.50	.46
d ₅₀	1.28	1.41	1.35	(⁴)	(⁴)	.50	1.27	1.05	1.19	1.36	(⁴)	.73	.70	.64
d ₆₅	1.75	1.88	1.86	(⁴)	(⁴)	.66	1.85	1.53	1.78	1.86	(⁴)	1.05	1.04	.91
d ₈₄	3.02	3.06	3.17	(⁴)	(⁴)	1.38	3.29	2.80	3.19	3.10	(⁴)	1.78	2.04	1.77
d ₈₅	5.97	5.43	6.07	(⁴)	(⁴)	2.70	6.44	5.72	6.12	5.27	(⁴)	3.11	3.85	3.53

Date ¹	6-23-75	6-24-75	6-25-75	6-26-75	7-01-75	7-08-75	5-18-76	5-19-76	5-20-76	5-20-76	5-21-76	5-22-76	5-26-76	5-27-76
Q ²	8.24	10.8	21.7	13.1	23.1	21.5	9.87	14.8	18.9	19.6	22.4	17.5	9.77	14.3
b ³	0.0062	0.0194	0.0838	0.0396	0.2159	0.0317	0.0838	0.1359	0.1163	0.1295	0.1769	0.0754	0.0130	0.0232

Percent by weight finer than sieve size (mm) indicated

0.06	0.4	0.6	0.4	0.4	0.2	0.2	0.5	0.3	0.3	0.3	0.3	1.4	0.3	0.5
0.09	.7	.7	.4	.5	.3	.3	.7	.5	.4	.4	.3	1.5	.4	.7
0.12	1.0	1.0	.4	.7	.5	.5	.9	.7	.5	.6	.4	1.6	.6	.9
0.18	1.7	1.5	.7	1.1	.8	.8	1.3	1.0	.9	.9	.7	1.9	.9	1.7
0.25	4.1	3.2	1.5	1.8	1.7	2.2	2.2	1.8	1.7	1.6	1.1	2.6	2.6	4.7
0.35	15.5	12.7	5.9	5.5	6.2	10.3	7.8	5.7	5.8	4.9	3.8	5.8	12.0	19.8
0.50	29.8	24.2	17.8	15.6	11.7	24.1	22.0	18.3	18.5	15.3	11.1	12.5	31.6	42.0
0.71	45.7	36.4	33.5	32.1	20.3	40.2	38.0	34.9	37.1	33.4	22.9	22.9	50.1	58.3
1.00	61.9	50.7	46.5	49.4	30.7	53.5	50.7	48.3	51.9	48.3	33.9	33.2	61.0	67.4
1.41	75.0	64.1	58.7	66.9	43.6	66.6	64.4	62.3	66.9	63.0	46.8	45.8	70.9	75.3
2.00	85.1	77.6	70.6	82.5	59.1	76.7	78.3	75.9	80.2	76.6	61.5	60.4	80.9	82.9
2.83	92.1	88.1	80.7	92.4	73.2	84.6	88.3	86.1	88.8	86.3	73.8	73.9	88.7	89.2
4.00	96.6	94.9	89.0	97.6	85.4	91.0	94.2	92.4	93.7	91.8	82.0	84.6	94.1	94.0
5.66	98.5	98.2	93.5	99.1	92.3	94.2	97.3	96.4	96.5	95.2	87.6	92.6	97.3	97.8
8.00	99.3	99.8	96.9	99.7	96.5	96.5	98.7	98.5	98.0	97.1	90.3	97.0	97.3	99.4
11.3	99.8	100.0	98.7	100.0	98.3	97.9	98.7	99.0	98.6	97.9	94.3	98.8	98.6	100.0
16.0	100.0	-----	99.8	-----	99.0	98.6	99.5	99.0	99.2	98.1	96.8	99.4	100.0	-----
22.6	-----	-----	100.0	-----	99.2	99.2	100.0	99.4	99.9	98.4	97.5	100.0	-----	-----
32.0	-----	-----	-----	-----	100.0	100.0	-----	100.0	100.0	99.9	100.0	-----	-----	-----
45.0	-----	-----	-----	-----	-----	-----	-----	-----	-----	100.0	-----	-----	-----	-----
64.0	-----	-----	-----	-----	-----	-----	-----	-----	-----	-----	-----	-----	-----	-----

Particle size (mm) at given percent finer

d ₅	0.26	0.28	0.34	0.34	0.33	0.30	0.31	0.34	0.34	0.36	0.38	0.33	0.29	0.25
d ₁₀	.36	.39	.48	.50	.60	.42	.44	.48	.47	.51	.59	.57	.39	.33
d ₂₅	.56	.68	.74	.75	1.13	.64	.67	.71	.68	.73	1.03	1.05	.53	.45
d ₅₀	.77	.98	1.10	.99	1.63	.91	.98	1.04	.96	1.04	1.52	1.56	.71	.59
d ₆₅	1.08	1.44	1.69	1.36	2.30	1.35	1.43	1.51	1.35	1.48	2.20	2.24	1.14	.91
d ₈₄	1.92	2.44	3.22	2.09	3.83	2.76	2.40	2.61	2.31	2.59	4.51	3.93	2.28	2.12
d ₈₅	3.44	4.03	6.43	3.24	6.89	6.28	4.29	4.89	4.60	5.53	12.23	6.63	4.31	4.27

TABLE 5.—Particle-size distribution of bedload sediment, conveyor-belt sampler—Continued

Date ¹	5-27-76	5-27-76	5-28-76	5-28-76	5-29-76	5-29-76	5-30-76	5-31-76	5-31-76	6-01-76	6-01-76	6-02-76	6-02-76	6-03-76
Q ²	13.7	13.0	18.8	19.8	20.5	20.9	20.9	16.6	15.8	14.3	13.9	17.9	17.8	21.6
h ³	0.0301	0.0233	0.0437	0.0454	0.0712	0.0618	0.0774	0.0621	0.0405	0.0361	0.0325	0.0576	0.0463	0.0834

Percent by weight finer than sieve size (mm) indicated

0.06	0.4	0.3	0.3	0.3	0.6	0.3	0.2	0.2	0.2	0.2	0.2	0.2	0.2	1.0
.09	.5	.5	.4	.4	.7	.4	.3	.3	.3	.3	.3	.3	.3	1.1
.12	.7	.5	.6	.6	.9	.5	.4	.4	.4	.6	.5	.4	.4	1.2
.18	1.4	1.0	1.2	1.0	2.2	.9	.6	.6	.6	1.1	.8	.6	.6	1.5
.25	4.4	3.3	3.5	2.3	2.8	1.8	1.3	7.6	6.0	11.7	10.0	9.6	6.4	8.2
.35	19.5	13.2	13.6	8.5	8.1	6.1	5.6	21.1	19.0	27.3	25.5	23.4	18.2	19.4
.50	40.8	30.7	29.0	20.3	19.1	14.6	16.5	36.7	36.5	45.3	45.1	40.4	36.1	33.6
.71	56.3	47.5	42.5	34.7	32.3	24.8	30.1	47.5	49.3	57.0	58.2	52.3	48.8	44.6
1.00	65.8	58.4	51.4	46.3	42.2	33.7	41.3	58.0	61.6	67.5	69.3	63.1	59.8	55.9
1.41	74.5	68.7	60.2	58.5	52.6	43.9	53.1	68.8	73.5	77.5	79.2	74.0	69.6	67.5
2.00	83.0	78.8	69.8	71.2	64.3	56.6	65.9	78.2	83.1	85.6	87.3	83.4	78.5	76.9
2.83	89.6	87.2	78.2	81.6	75.5	70.1	77.5	86.1	90.4	91.8	93.0	91.3	86.3	83.9
4.00	94.3	92.8	85.8	89.6	85.1	81.7	86.8	92.4	95.6	95.5	96.6	96.1	91.5	89.1
5.66	97.2	96.8	91.6	94.8	92.2	90.3	93.5	96.4	98.4	97.9	98.8	98.9	95.2	92.9
8.00	98.7	98.6	95.8	97.9	96.2	94.3	97.5	98.2	99.1	98.9	99.7	99.5	96.5	95.1
11.3	99.2	100.0	97.3	98.8	98.0	95.8	98.8	99.1	100.0	99.6	100.0	100.0	98.3	95.9
16.0	99.6	-----	97.8	100.0	99.1	96.9	99.7	99.5	-----	100.0	-----	-----	99.8	95.9
22.6	100.0	-----	100.0	-----	99.7	98.2	100.0	99.8	-----	-----	-----	-----	100.0	97.2
32.0	-----	-----	-----	-----	100.0	100.0	-----	100.0	-----	-----	-----	-----	-----	100.0
45.0	-----	-----	-----	-----	-----	-----	-----	-----	-----	-----	-----	-----	-----	-----
64.0	-----	-----	-----	-----	-----	-----	-----	-----	-----	-----	-----	-----	-----	-----

Particle size (mm) at given percent finer

d ₅	0.26	0.27	0.27	0.30	0.30	0.33	0.34	0.32	0.34	0.28	0.30	0.30	0.33	0.30
d ₁₀	.33	.39	.38	.45	.46	.53	.49	.45	.47	.40	.41	.42	.48	.46
d ₂₅	.39	.55	.59	.71	.78	1.05	.83	.68	.69	.58	.60	.64	.69	.74
d ₅₀	.61	.77	.95	1.11	1.30	1.67	1.29	1.09	.98	.81	.80	.94	1.04	1.18
d ₆₅	.97	1.24	1.67	1.68	2.04	2.47	1.95	1.76	1.55	1.30	1.23	1.50	1.69	1.85
d ₈₄	2.11	2.46	3.68	3.11	3.84	4.35	3.58	3.64	2.95	2.63	2.44	2.90	3.59	4.06
d ₉₅	4.27	4.71	7.35	5.74	7.07	9.38	6.24	6.91	5.37	5.37	4.73	5.11	7.81	11.03

Date ¹	6-04-76	6-05-76	6-05-76	6-06-76	6-07-76	6-08-76	6-09-76	6-09-76	6-10-76	6-11-76	6-11-76	6-11-76	6-11-76	6-11-76
Q ²	21.8	21.4	22.4	22.6	24.6	21.1	18.8	18.9	18.2	13.8	14.5	15.7	15.2	14.4
h ³	0.0871	0.0918	0.0784	0.0908	0.0869	0.0570	0.0513	0.0346	0.0290	0.0253	0.0289	0.0280	0.0629	0.0236

Percent by weight finer than sieve size (mm) indicated

0.06	0.2	0.2	0.2	0.2	0.2	0.2	0.3	0.2	0.2	0.3	0.3	0.3	0.2	0.3
.09	.3	.2	.2	.2	.3	.3	.4	.3	.3	.4	.4	.4	.3	.5
.12	.6	.4	.3	.3	.4	.4	.5	.4	.4	.6	.5	.5	.4	.7
.18	.8	.6	.5	.6	.7	.6	.8	.7	.7	.8	.7	.8	.7	1.1
.25	1.4	1.2	1.1	1.2	1.3	1.2	1.8	1.6	1.6	1.7	1.7	1.7	2.0	2.5
.35	5.4	4.6	4.4	5.3	5.9	4.9	7.5	6.7	7.5	7.1	6.8	6.7	9.3	10.6
.50	14.1	12.3	13.7	16.9	18.6	14.9	19.9	17.5	19.0	21.3	17.6	17.6	22.1	26.5
.71	27.5	23.3	25.8	30.1	33.3	29.7	36.3	33.5	35.3	42.5	34.2	34.9	37.0	45.5
1.00	38.9	33.1	36.4	40.9	42.6	42.1	48.8	47.0	47.8	57.7	48.1	49.1	47.8	59.2
1.41	50.3	43.2	47.8	52.8	51.2	55.0	61.0	60.3	59.9	70.5	61.6	62.3	58.5	71.0
2.00	61.3	53.9	59.5	65.1	60.3	68.0	73.2	72.5	72.0	81.2	75.0	75.0	71.7	81.5
2.83	70.3	64.2	69.4	75.3	69.3	78.6	83.6	82.2	82.3	88.8	86.6	85.4	81.6	89.3
4.00	77.6	73.8	77.9	83.0	77.8	87.1	90.8	89.2	90.0	93.8	84.4	92.1	89.8	94.6
5.66	87.1	83.2	86.0	89.6	85.3	92.4	96.1	94.2	95.0	97.3	95.5	96.8	95.4	98.2
8.00	93.4	92.0	92.4	94.6	92.0	95.6	98.8	97.1	98.1	98.9	98.8	99.3	98.2	99.4
11.3	96.5	97.3	96.1	97.5	96.5	97.6	99.7	98.2	99.0	100.0	100.0	100.0	99.3	100.0
16.0	98.2	99.4	99.0	98.9	98.6	99.9	100.0	100.0	99.6	-----	-----	-----	100.0	-----
22.6	99.0	100.0	100.0	99.2	100.0	100.0	-----	-----	100.0	-----	-----	-----	-----	-----
32.0	99.5	-----	-----	99.5	-----	-----	-----	-----	-----	-----	-----	-----	-----	-----
45.0	100.0	-----	-----	100.0	-----	-----	-----	-----	-----	-----	-----	-----	-----	-----
64.0	-----	-----	-----	-----	-----	-----	-----	-----	-----	-----	-----	-----	-----	-----

Particle size (mm) at given percent finer

d ₅	0.34	0.36	0.37	0.35	0.34	0.36	0.32	0.33	0.32	0.32	0.33	0.33	0.30	0.29
d ₁₀	.53	.57	.54	.49	.47	.51	.46	.48	.46	.45	.48	.48	.43	.41
d ₂₅	.89	1.07	.96	.83	.75	.82	.69	.74	.70	.63	.72	.71	.68	.59
d ₅₀	1.40	1.76	1.51	1.30	1.35	1.24	1.03	1.08	1.06	.84	1.05	1.02	1.07	.79
d ₆₅	2.30	2.91	2.41	1.99	2.39	1.84	1.58	1.61	1.63	1.21	1.54	1.51	1.67	1.18
d ₈₄	5.01	5.83	5.18	4.22	5.33	3.50	2.89	3.08	3.03	2.25	2.59	2.69	3.10	2.22
d ₉₅	9.33	9.35	9.97	8.31	9.83	7.42	5.16	6.08	5.65	4.40	4.14	4.81	5.49	4.10

TABLE 5.—Particle-size distribution of bedload sediment, conveyor-belt sampler—Continued

Date ¹	6-12-76	6-12-76	6-12-76	6-12-76	6-12-76	6-12-76	6-13-76	6-14-76	6-14-76	5-15-76	6-15-76	6-16-76	6-18-76	6-19-76	6-20-76	6-21-76
Q ²	13.1	12.5	11.2	10.5	9.64	8.50	6.53	4.97	4.65	3.87	3.44	4.97	3.90	4.20	4.57	9.53
J ³	0.0181	0.0169	0.0162	0.0145	0.0106	0.0084	0.0028	0.0022	0.0020	0.0003	0.0004	0.0009	0.0006	0.0009	0.0023	0.0181

Percent by weight finer than sieve size (mm) indicated

0.06	0.3	0.4	0.2	0.2	0.3	0.2	0.8	2.3	1.7	0.4	0.2	0.4	1.0	0.5	0.6	0.3
0.09	.5	.5	.3	.3	.4	.3	1.2	3.7	2.7	.6	.4	.7	1.5	.8	.8	.5
.12	.6	.7	.4	.5	.6	.6	1.8	5.9	4.6	1.2	.8	1.2	2.4	1.3	1.3	.7
.18	1.0	1.1	.8	.9	.9	1.1	3.8	10.3	7.8	2.7	1.8	3.5	5.4	3.8	4.6	1.9
.25	2.4	2.6	2.1	2.4	2.3	2.7	10.4	20.7	14.2	7.2	5.1	8.7	13.5	10.5	10.9	3.6
.35	9.8	11.1	9.5	10.0	8.9	10.3	28.2	41.2	28.6	20.1	14.7	26.4	37.8	34.3	35.9	17.4
.50	25.3	27.5	24.2	24.8	22.9	26.0	51.2	62.2	46.9	37.5	29.6	50.3	61.9	60.4	62.1	37.7
.71	44.7	46.9	44.3	43.7	43.0	46.4	72.0	77.8	63.7	53.5	44.1	70.0	77.7	75.2	77.0	51.4
1.00	58.6	60.2	59.4	58.9	58.8	61.8	83.4	89.9	78.5	70.6	61.1	87.3	89.7	85.4	84.1	60.0
1.41	70.2	71.6	72.6	72.1	72.2	74.9	90.8	95.4	87.4	81.6	74.8	93.0	92.4	88.0	92.8	77.6
2.00	80.3	81.7	83.6	83.3	82.7	85.4	95.4	99.3	95.1	91.3	85.2	94.0	94.3	90.1	95.3	91.1
2.83	87.9	89.8	91.2	91.2	89.5	92.8	97.9	99.3	96.8	93.3	87.8	94.9	94.8	90.6	95.6	95.7
4.00	93.7	94.9	95.8	96.7	94.5	97.0	99.3	99.3	98.3	95.0	91.1	90.4	96.3	91.9	96.9	98.5
5.66	97.8	97.6	98.4	98.7	97.6	99.3	100.0	99.6	99.6	97.9	91.1	94.3	96.6	93.4	98.0	99.3
8.00	99.5	99.0	100.0	100.0	97.6	99.8	-----	99.6	99.2	94.3	94.3	96.6	96.5	100.0	98.7	100.0
11.3	100.0	99.3	100.0	-----	98.5	100.0	-----	100.0	99.2	98.2	96.2	100.0	98.2	100.0	100.0	-----
16.0	-----	100.0	-----	-----	100.0	-----	-----	-----	100.0	100.0	-----	-----	-----	-----	-----	-----
22.6	-----	-----	-----	-----	-----	-----	-----	-----	-----	-----	-----	-----	-----	-----	-----	-----
32.0	-----	-----	-----	-----	-----	-----	-----	-----	-----	-----	-----	-----	-----	-----	-----	-----
45.0	-----	-----	-----	-----	-----	-----	-----	-----	-----	-----	-----	-----	-----	-----	-----	-----
64.0	-----	-----	-----	-----	-----	-----	-----	-----	-----	-----	-----	-----	-----	-----	-----	-----

Particle size (mm) at given percent finer

d ₅	0.30	0.29	0.30	0.30	0.30	0.29	0.19	0.11	0.13	0.22	0.25	0.20	0.17	0.19	0.18	0.27
d ₁₀	.42	.40	.42	.42	.43	.41	.28	.22	.26	.32	.37	.30	.26	.28	.27	.35
d ₂₅	.60	.58	.61	.61	.62	.59	.39	.32	.40	.48	.57	.40	.34	.36	.35	.48
d ₅₀	.81	.77	.81	.82	.82	.77	.49	.41	.53	.66	.88	.50	.42	.44	.43	.68
d ₈₅	1.21	1.15	1.15	1.17	1.17	1.08	.63	.53	.74	1.09	1.69	.64	.53	.55	.53	1.22
d ₉₅	2.35	2.19	2.04	2.06	2.13	1.90	1.03	.94	2.14	3.58	5.13	1.19	.96	1.26	1.00	2.68
d ₉₈	4.34	4.02	3.71	3.48	4.17	3.30	1.92	2.77	5.65	11.78	12.65	5.83	6.18	11.67	3.14	5.31

¹Dates correspond to dates listed in table 4.

²Discharge over 14.6-m width of bedload trap; includes all flow over the active width of the streambed.

³Unit transport rate of solids in dry weight per second, over 14.6-m width of bedload trap.

⁴Indicates sieve analysis not available.

TABLE 6.—Summary data of river hydraulics and bedload transport, Helley-Smith sampler

Date ¹	River discharge		Mean depth, ⁴ <i>D</i> (m)	Mean velocity, ⁵ <i>V</i> (m/s)	Unit bedload-transport rate, ⁶ <i>J_b</i> (kg/m-s)	Bedload size, ⁷ <i>d₅₀</i> (mm)
	Total, ² <i>Q</i> (m ³ /s)	Effective, ³ <i>Q'</i> (m ³ /s)				
6-01-73	16.6	15.8	1.02	1.06	0.0065	0.45
6-02-73	18.5	17.5	1.10	1.09	.0277	.58
6-03-73	18.0	17.0	1.08	1.08	.0425	.71
6-06-73	11.9	11.4	.81	.96	.0074	.56
6-07-73	16.4	15.6	1.02	1.06	.0383	.60
6-08-73	19.7	18.6	1.15	1.11	.0059	.42
6-09-73	28.3	26.4	1.47	1.23	.1106	1.53
6-09-73	27.6	25.8	1.45	1.23	.1624	1.13
5-24-74	2.95	2.95	.31	.64	.0015	1.22
5-25-74	5.44	5.34	.48	.77	.0046	.41
5-26-74	10.8	10.4	.76	.94	.0451	.50
5-26-74	10.1	9.73	.73	.92	.0583	.65
5-27-74	23.3	21.9	1.29	1.17	.1702	.98
5-28-74	29.7	27.7	1.52	1.25	.1532	1.07
5-28-74	32.6	30.3	1.62	1.29	.2533	1.15
5-29-74	45.3	41.8	2.03	1.42	.3025	1.14
5-30-74	36.4	33.8	1.74	1.33	.1227	1.76
5-31-74	25.1	23.5	1.35	1.19	.0768	1.14
6-01-74	25.8	24.2	1.38	1.20	.0200	.68
6-02-74	27.5	25.7	1.44	1.23	.0106	.40
6-03-74	31.9	29.7	1.60	1.28	.0233	.49
6-04-74	30.0	28.0	1.53	1.26	.0307	.59
6-05-74	28.3	26.4	1.47	1.23	.0447	.70
5-25-75	2.35	2.35	.27	.60	.0061	.82
5-25-75	2.35	2.35	.27	.60	.0024	.48
5-26-75	2.41	2.41	.27	.60	.0050	.74
5-26-75	2.38	2.38	.27	.60	.0075	.57
5-27-75	2.44	2.44	.28	.61	.0034	.70
5-27-75	2.44	2.44	.28	.61	.0062	.49
6-01-75	3.26	3.25	.34	.66	.0080	.49
6-01-75	3.26	3.25	.34	.66	.0086	.61
6-02-75	5.38	5.28	.47	.76	.0649	.64
6-02-75	5.35	5.25	.47	.76	.0749	.87
6-03-75	9.06	8.75	.68	.89	.0093	.78
6-04-75	10.1	9.73	.73	.92	.0983	.99
6-05-75	10.6	10.2	.75	.93	.0512	1.06
6-05-75	10.5	10.1	.75	.93	.0829	1.05
6-06-75	20.9	19.7	1.20	1.13	.1076	.90
6-06-75	21.3	20.1	1.21	1.14	.0860	.97
6-07-75	26.9	25.2	1.42	1.22	.1262	.95
6-07-75	27.0	25.3	1.43	1.22	.0474	.68
6-07-75	26.6	24.9	1.41	1.21	.2168	.93
6-07-75	26.4	24.7	1.40	1.21	.1896	1.27
6-08-75	27.4	25.6	1.44	1.22	.2027	1.24
6-08-75	27.5	25.7	1.44	1.23	.1025	1.28
6-09-75	27.1	25.4	1.43	1.22	.1185	.82
6-09-75	27.1	25.4	1.43	1.22	.1054	1.50
6-10-75	17.0	16.1	1.04	1.07	.0674	1.11
6-10-75	16.7	15.9	1.03	1.06	.0298	1.41
6-11-75	10.9	10.5	.77	.94	.0210	1.15
6-11-75	10.8	10.4	.76	.94	.0225	1.02
6-12-75	10.7	10.3	.76	.93	.0112	.49
6-12-75	10.6	10.2	.75	.93	.0125	.48
6-13-75	16.7	15.9	1.03	1.06	.0337	.70
6-13-75	16.7	15.9	1.03	1.06	.0252	.44
6-17-75	24.5	23.0	1.33	1.19	.0879	1.58
6-17-75	24.5	23.0	1.33	1.19	.1052	1.38
6-18-75	13.7	13.1	.90	1.00	.0265	.57
6-18-75	13.7	13.1	.90	1.00	.0195	.59
6-19-75	10.9	10.5	.77	.94	.0163	.70

TABLE 6.—Summary data of river hydraulics and bedload transport, Helley-Smith sampler—Continued

Date ¹	River discharge		Mean depth, ⁴ <i>D</i> (m)	Mean velocity, ⁵ <i>V</i> (m/s)	Unit Bedload-transport rate, ⁶ $\frac{b}{h}$ (kg/m-s)	Bedload size, ⁷ <i>d</i> ₅₀ (mm)
	Total, ² <i>Q</i> (M ³ /s)	Effective, ³ <i>Q'</i> (m ³ /s)				
6-19-75	10.9	10.5	.77	.94	.0114	.65
6-20-75	7.14	6.95	.57	.83	.0040	.55
6-20-75	7.14	6.95	.57	.83	.0045	.50
6-21-75	7.70	7.48	.61	.85	.0039	.52
6-21-75	7.70	7.48	.61	.85	.0051	.65
6-22-75	7.48	7.27	.59	.84	.0075	.81
6-22-75	7.48	7.27	.59	.84	.0099	.56
6-23-75	8.44	8.17	.64	.87	.0096	.92
6-23-75	8.44	8.17	.64	.87	.0154	1.08
6-24-75	11.3	10.9	.79	.95	.0254	.82
6-24-75	11.3	10.9	.79	.95	.0183	.78
6-25-75	21.5	20.3	1.22	1.14	.0926	.88
6-25-75	21.7	20.4	1.23	1.14	.0814	.99
6-25-75	23.3	21.9	1.29	1.17	.0912	1.19
6-25-75	23.3	21.9	1.29	1.17	.0725	1.56
6-26-75	15.9	15.1	.99	1.05	.0684	.82
6-26-75	15.7	14.9	.98	1.04	.0976	.76
6-26-75	11.8	11.3	.81	.96	.0513	1.04
6-26-75	11.6	11.1	.80	.95	.0683	1.03
5-28-76	21.4	20.1	1.23	1.11	.0390	.65
5-28-76	21.1	19.9	1.23	1.11	.0822	.64
5-29-76	22.4	21.0	1.27	1.13	.1205	1.14
5-29-76	22.4	21.0	1.27	1.13	.0977	.56

¹Dates correspond to dates listed in table 7.²Complete river discharge including overbank flow.³Discharge over 14.6-m width of bedload trap; includes all flow over the active width of the streambed.⁴Mean depth over effective width W ; $D = \frac{Q'}{VW}$ ⁵Mean velocity of effective discharge; $V = \frac{Q'}{WD} = \frac{Q'}{14.6D}$ ⁶Unit transport rate of solids in dry weight per second, over 14.6-m width of bedload trap.⁷ d_{50} is median diameter of grains; complete grain-size data are given in table 7.

TABLE 7.—Particle size distribution of bedload sediment, Helley-Smith sampler

Date ¹	6-01-73	6-02-73	6-03-73	6-06-73	6-07-73	6-08-73	6-09-73	6-09-73	5-24-74	5-25-74	5-26-74	5-26-74	5-27-74	5-28-74
Q ²	15.8	17.5	17.0	11.4	15.6	18.6	26.4	25.8	2.95	5.34	10.4	9.73	21.9	27.7
k ³	0.0065	0.0277	0.0425	0.0074	0.0383	0.0059	0.1106	0.1624	0.0015	0.0046	0.0451	0.0583	0.1702	0.1532

Percent by weight finer than sieve size (mm) indicated

0.06	0.1	0.3	0.2	0.1	0.3	0.4	0.1	0.1	0.1	0.5	0.3	0.0	0.1	0.1
.09	.4	.5	.3	.3	.4	.8	.1	.2	.2	1.1	.5	0.0	.2	.2
.12	1.1	.8	.5	.6	.7	1.2	.2	.3	.7	2.2	.9	.5	.4	.3
.18	3.1	1.8	1.1	1.7	1.5	2.4	.4	.6	1.6	4.1	1.7	1.0	.7	.6
.25	9.6	5.2	3.2	7.5	4.7	10.0	1.1	1.7	6.9	15.7	5.1	4.0	1.6	1.9
.35	30.7	17.5	10.3	26.3	16.4	35.7	3.1	4.6	16.5	42.1	19.3	12.9	4.5	5.3
.50	57.7	41.1	26.7	44.4	40.1	65.7	7.6	12.3	27.1	60.7	49.5	33.8	14.4	14.7
.71	71.6	62.7	50.1	62.0	58.3	82.6	17.4	31.7	37.8	72.5	69.4	53.9	31.4	30.2
1.00	77.9	73.1	65.4	70.6	67.4	88.0	29.5	45.7	46.2	80.9	79.4	66.7	51.2	46.9
1.41	83.0	81.3	77.3	77.7	76.6	91.3	45.2	57.9	52.9	87.2	87.2	77.6	66.7	61.8
2.00	87.9	88.5	86.9	84.1	86.5	94.0	66.1	71.1	61.1	92.2	93.5	88.6	80.3	74.9
2.83	92.2	93.8	93.2	89.0	94.1	96.1	83.2	82.4	71.4	95.7	96.9	94.7	89.7	85.6
4.00	95.9	97.5	97.4	92.7	97.9	97.5	93.1	91.6	78.4	97.5	98.7	98.0	95.2	95.1
5.66	98.2	98.8	99.1	95.2	99.3	98.6	96.8	96.2	83.9	98.5	99.5	99.3	97.9	98.0
8.00	99.4	99.6	99.8	97.6	99.8	99.2	98.9	98.6	87.0	99.4	99.8	100.0	99.2	99.1
11.3	99.4	99.8	100.0	99.5	100.0	100.0	99.7	99.5	88.3	100.0	100.0	-----	100.0	99.5
16.0	100.0	100.0	-----	100.0	-----	-----	100.0	100.0	100.0	-----	-----	-----	-----	99.8
22.6	-----	-----	-----	-----	-----	-----	-----	-----	-----	-----	-----	-----	-----	100.0
32.0	-----	-----	-----	-----	-----	-----	-----	-----	-----	-----	-----	-----	-----	-----
45.0	-----	-----	-----	-----	-----	-----	-----	-----	-----	-----	-----	-----	-----	-----
64.0	-----	-----	-----	-----	-----	-----	-----	-----	-----	-----	-----	-----	-----	-----

Particle size (mm) at given percent finer

d ₅	0.20	0.25	0.28	0.23	0.25	0.21	0.42	0.36	0.23	0.18	0.25	0.27	0.36	0.35
d ₁₀	.29	.34	.41	.30	.35	.28	.68	.54	.35	.25	.33	.37	.52	.52
d ₂₅	.38	.46	.57	.42	.47	.35	1.14	.77	.65	.33	.43	.50	.76	.79
d ₅₀	.45	.58	.71	.56	.60	.42	1.53	1.13	1.22	.41	.50	.65	.98	1.07
d ₇₅	.60	.76	.99	.80	.91	.50	1.96	1.69	2.27	.56	.65	.94	1.36	1.53
d ₈₄	1.52	1.60	1.79	2.00	1.82	.77	2.90	2.98	5.80	1.18	1.22	1.65	2.26	2.68
d ₉₅	3.61	3.09	3.18	5.47	3.00	2.32	4.66	5.05	12.3	2.60	2.26	3.30	3.93	3.98

Date ¹	5-28-74	5-29-74	5-30-74	5-31-74	6-01-74	6-02-74	6-03-74	6-04-74	6-05-74	5-25-75	5-25-74	5-26-75	5-26-75	5-27-75
Q ²	30.3	41.8	33.8	23.5	24.2	25.7	29.7	28.0	26.4	2.35	2.35	2.41	2.38	2.44
k ³	0.2533	0.3025	0.1227	0.0768	0.0200	0.0106	0.0233	0.0307	0.0447	0.0061	0.0024	0.0050	0.0075	0.0034

Percent by weight finer than sieve (mm) indicated

0.06	0.1	0.2	0.1	0.1	0.2	0.3	0.3	0.2	0.2	0.3	0.8	0.7	0.5	0.5
.09	.2	.3	.1	.2	.5	.7	.6	.4	.4	.6	.8	.7	.7	1.1
.12	.3	.4	.2	.3	1.0	1.3	1.1	.7	.6	.8	1.1	1.0	1.0	1.1
.18	.5	.6	.4	.6	1.7	2.2	1.8	1.6	1.1	.9	1.5	1.5	1.2	1.6
.25	1.3	1.3	1.2	2.3	8.6	10.7	6.9	6.3	2.9	3.0	4.6	3.6	4.2	3.8
.35	4.0	4.1	2.9	8.6	30.0	41.1	29.2	21.5	11.3	12.0	19.8	12.0	15.2	11.4
.50	11.7	11.8	6.6	15.1	42.6	66.7	49.4	42.6	32.0	28.7	54.2	28.8	39.6	27.7
.71	26.3	26.1	14.3	25.9	49.4	72.3	62.7	59.0	51.0	45.5	81.7	47.8	66.3	50.5
1.00	43.1	44.5	26.0	45.3	56.5	75.8	72.1	70.9	64.4	56.0	92.4	64.6	85.3	72.8
1.41	59.7	59.0	40.6	58.0	63.9	79.3	78.4	78.3	75.2	70.4	96.9	81.8	94.6	91.8
2.00	74.2	71.7	55.4	71.3	72.1	83.2	83.8	84.8	85.0	87.1	99.2	94.5	98.5	98.9
2.83	84.8	81.5	69.2	82.1	79.6	87.1	88.1	89.8	91.6	98.5	100.0	98.2	99.5	99.5
4.00	91.8	88.5	81.5	70.4	86.3	91.0	92.8	93.6	95.7	99.7	-----	99.3	99.8	100.0
5.66	95.6	93.6	89.6	94.9	90.9	94.1	94.9	96.0	97.6	100.0	-----	99.6	100.0	-----
8.00	97.6	96.8	95.2	97.7	94.5	96.9	97.2	97.6	99.0	-----	-----	100.0	-----	-----
11.3	98.6	98.4	98.0	99.0	96.7	98.6	98.5	98.7	99.5	-----	-----	-----	-----	-----
16.0	99.3	99.3	99.6	99.8	98.0	99.3	99.2	99.4	100.0	-----	-----	-----	-----	-----
22.6	100.0	99.8	100.0	100.0	99.4	100.0	99.4	99.7	-----	-----	-----	-----	-----	-----
32.0	-----	100.0	-----	-----	100.0	-----	100.0	100.0	-----	-----	-----	-----	-----	-----
45.0	-----	-----	-----	-----	-----	-----	-----	-----	-----	-----	-----	-----	-----	-----
64.0	-----	-----	-----	-----	-----	-----	-----	-----	-----	-----	-----	-----	-----	-----

Particle size (mm) at given percent finer

d ₅	0.38	0.38	0.44	0.30	0.22	0.21	0.23	0.23	0.28	0.28	0.25	0.27	0.26	0.27
d ₁₀	.56	.56	.75	.51	.29	.27	.30	.32	.39	.39	.33	.39	.36	.40
d ₂₅	.85	.84	1.25	.84	.41	.33	.39	.45	.53	.57	.42	.56	.47	.56
d ₅₀	1.15	1.14	1.76	1.14	.68	.40	.49	.59	.70	.82	.48	.74	.57	.70
d ₇₅	1.59	1.66	2.53	1.69	1.48	.49	.77	.84	1.02	1.24	.56	1.01	.69	.88
d ₈₄	2.76	3.18	4.42	3.04	3.54	2.16	2.05	1.92	1.93	1.85	.75	1.48	.97	1.19
d ₉₅	5.29	6.44	7.86	5.71	8.56	6.21	5.73	4.82	3.72	2.37	1.19	2.07	1.45	1.56

TABLE 7.—Particle size distribution of bedload sediment, Helley-Smith sampler—Continued

Date ¹	5-27-75	6-01-75	6-01-75	6-02-75	6-02-75	6-03-75	6-04-75	6-05-75	6-05-75	6-06-75	6-06-75	6-07-75	6-07-75	6-07-75
Q ²	2.44	3.25	3.25	5.28	5.25	8.76	9.73	10.2	10.1	19.7	20.1	25.2	25.3	24.9
b ³	0.0062	0.0080	0.0086	0.0649	0.0749	0.0093	0.0983	0.0512	0.0829	0.1076	0.0860	0.1262	0.0474	0.2168

Percent by weight finer than sieve size (mm) indicated

0.06	0.6	0.7	0.4	0.4	0.4	0.9	0.3	0.5	0.3	0.4	0.5	0.5	0.6	0.3
.09	.9	.9	.6	.5	.4	1.3	.3	.7	.4	.6	.7	.5	.7	.3
.12	1.2	1.4	.8	.7	.6	1.7	.5	.9	.6	.8	.9	.7	1.1	.5
.18	1.5	2.7	1.7	1.1	1.0	2.7	.7	1.4	.9	1.3	1.4	1.2	1.7	.7
.25	4.1	12.6	8.1	3.9	2.8	6.4	1.6	3.0	2.0	3.2	3.8	3.5	5.3	1.9
.35	19.4	31.1	20.2	18.0	12.1	16.5	4.7	7.9	5.5	9.0	9.5	8.8	13.4	4.7
.50	53.2	51.1	39.1	36.7	26.8	32.6	13.8	17.5	14.6	21.8	21.5	21.1	29.6	14.4
.71	83.8	69.4	58.4	55.6	42.4	46.6	32.0	33.1	31.7	39.9	37.4	38.7	52.3	34.8
1.00	95.0	81.1	72.8	68.7	55.2	58.8	50.4	47.6	47.6	54.6	51.1	52.2	70.4	54.4
1.41	98.8	89.3	80.9	80.8	69.1	70.6	65.0	63.0	63.3	67.5	63.1	64.5	84.0	69.8
2.00	99.4	93.6	85.1	90.8	83.6	82.4	78.7	79.2	78.9	79.0	75.0	76.0	92.9	81.8
2.83	99.7	96.1	87.0	96.3	92.9	91.7	89.2	90.6	89.9	87.8	85.2	85.3	96.9	89.4
4.00	100.0	97.3	88.1	98.6	97.9	97.3	96.3	96.9	96.8	94.2	92.8	92.7	98.7	94.1
5.66	-----	97.7	89.0	99.5	99.1	98.5	98.8	99.0	99.0	97.1	96.3	96.0	99.5	96.5
8.00	-----	98.6	89.8	99.8	99.7	99.5	99.7	99.8	99.8	98.6	98.4	98.0	100.0	98.2
11.3	-----	99.3	90.9	100.0	100.0	99.5	100.0	100.0	100.0	99.4	99.3	99.1	-----	99.2
16.0	-----	100.0	93.8	-----	-----	100.0	-----	-----	-----	99.6	100.0	99.5	-----	100.0
22.6	-----	-----	100.0	-----	-----	-----	-----	-----	-----	100.0	-----	100.0	-----	-----
32.0	-----	-----	-----	-----	-----	-----	-----	-----	-----	-----	-----	-----	-----	-----
45.0	-----	-----	-----	-----	-----	-----	-----	-----	-----	-----	-----	-----	-----	-----
64.0	-----	-----	-----	-----	-----	-----	-----	-----	-----	-----	-----	-----	-----	-----

Particle size (mm) at given percent finer

d ₅	0.26	0.20	0.22	0.26	0.28	0.23	0.36	0.30	0.34	0.29	0.28	0.28	0.25	0.36
d ₁₆	.33	.27	.32	.34	.39	.35	.53	.48	.52	.44	.43	.44	.38	.52
d ₃₅	.42	.38	.47	.49	.60	.53	.75	.74	.76	.65	.67	.66	.55	.71
d ₅₀	.49	.49	.61	.64	.87	.78	.99	1.06	1.05	.90	.97	.95	.68	.93
d ₆₅	.56	.65	.82	.90	1.27	1.19	1.41	1.47	1.46	1.32	1.49	1.43	.90	1.26
d ₈₄	.71	1.12	1.84	1.56	2.03	2.11	2.35	2.27	2.31	2.41	2.71	2.69	1.42	2.20
d ₉₅	1.00	2.39	16.4	2.54	3.15	3.34	3.66	3.48	3.53	4.32	4.87	5.00	2.33	4.48

Date ¹	6-07-75	6-08-75	6-08-75	6-09-75	6-09-75	6-10-75	6-10-75	6-11-75	6-11-75	6-12-75	6-12-75	6-13-75	6-13-75	6-17-75
Q ²	24.7	25.6	25.7	25.4	25.4	16.1	15.9	10.5	10.4	10.3	10.2	15.9	15.9	23.0
b ³	0.1896	0.2027	0.1025	0.1185	0.1054	0.0674	0.0298	0.0210	0.0225	0.0112	0.0125	0.0337	0.0252	0.0879

Percent by weight finer than sieve size (mm) indicated

0.06	0.3	0.2	0.5	0.4	0.3	0.4	0.4	0.7	0.5	1.0	0.9	0.6	0.8	0.3
.09	.3	.4	.6	.5	.3	.5	.5	.9	.7	1.3	1.2	.8	1.1	.4
.12	.5	.5	.8	.8	.5	.7	.7	1.1	1.0	1.6	1.5	1.1	1.5	.5
.18	.7	.7	1.1	1.1	.6	1.0	1.0	1.6	1.4	2.3	2.2	1.8	2.3	.7
.25	1.6	2.0	3.3	3.5	2.8	2.5	3.9	5.3	5.1	10.5	9.5	7.2	9.4	1.8
.35	3.3	4.9	7.9	13.9	9.9	7.7	10.4	16.1	15.9	35.5	34.9	24.8	37.9	6.2
.50	8.8	9.9	14.1	25.6	16.4	15.0	15.7	24.0	25.0	49.5	52.0	37.4	58.3	10.7
.71	22.7	22.7	25.3	43.5	24.1	27.2	23.6	34.2	35.6	61.1	69.1	49.7	70.0	18.1
1.00	39.1	39.1	37.9	58.7	34.0	44.1	34.3	45.1	49.0	68.3	83.4	59.8	75.9	27.9
1.41	55.2	56.8	54.9	71.2	47.2	63.1	50.2	57.6	64.0	74.7	90.9	70.0	80.6	43.3
2.00	71.0	73.8	72.4	81.4	62.9	80.1	69.8	71.4	79.2	80.7	94.6	80.8	84.8	63.8
2.83	83.4	85.8	82.7	88.9	76.9	91.5	85.1	82.8	90.2	87.4	96.5	89.7	88.6	80.0
4.00	91.8	93.3	91.0	94.4	89.0	97.2	94.3	91.8	96.8	93.8	98.1	95.6	92.0	90.6
5.66	96.0	97.1	94.8	97.2	94.2	99.1	98.3	96.7	98.8	97.9	99.1	98.4	96.4	96.0
8.00	98.2	98.9	98.0	99.2	97.6	99.8	99.8	99.0	99.7	99.5	100.0	99.5	99.7	98.8
11.3	99.4	99.7	99.6	100.0	99.2	100.0	100.0	99.6	99.8	100.0	-----	10.0	100.0	99.8
16.0	100.0	100.0	100.0	-----	100.0	-----	-----	100.0	100.0	-----	-----	-----	-----	100.0
22.6	-----	-----	100.0	-----	-----	-----	-----	-----	-----	-----	-----	-----	-----	-----
32.0	-----	-----	-----	-----	-----	-----	-----	-----	-----	-----	-----	-----	-----	-----
45.0	-----	-----	-----	-----	-----	-----	-----	-----	-----	-----	-----	-----	-----	-----
64.0	-----	-----	-----	-----	-----	-----	-----	-----	-----	-----	-----	-----	-----	-----

Particle size (mm) at given percent finer

d ₅	0.41	0.36	0.29	0.27	0.29	0.31	0.27	0.25	0.25	0.21	0.21	0.23	0.21	0.23
d ₁₆	.61	.60	.53	.38	.49	.52	.50	.35	.35	.28	.28	.31	.28	.64
d ₃₅	.92	.92	.93	.60	1.03	.84	1.02	.73	.69	.35	.35	.47	.34	1.18
d ₅₀	1.27	1.24	1.28	.82	1.50	1.11	1.41	1.15	1.02	.49	.48	.70	.44	1.58
d ₆₅	1.74	1.66	1.71	1.18	2.10	1.46	1.83	1.69	1.44	.85	.65	1.19	.61	2.05
d ₈₄	2.90	2.67	2.97	2.24	3.41	2.21	2.75	2.95	2.29	2.36	1.03	2.24	1.89	3.17
d ₉₅	5.11	4.55	5.75	4.25	6.02	3.37	4.17	4.87	3.52	4.31	2.13	3.81	4.94	5.20

SEDIMENT-TRAPPING CHARACTERISTICS OF THE HELLEY-SMITH BEDLOAD SAMPLER

TABLE 7.—Particle size distribution of bedload sediment, Helley-Smith sampler—Continued

Date ¹	6-17-75	6-18-75	6-18-75	6-19-75	6-19-75	6-20-75	6-20-75	6-21-75	6-21-75	6-21-75	6-22-75	6-22-75	6-23-75	6-23-75	6-24-75
Q ²	23.0	13.1	13.1	10.5	10.5	6.95	6.95	7.48	7.48	7.27	7.27	8.17	8.17	10.9	
k ³	0.1052	0.0265	0.0195	0.0163	0.0114	0.0040	0.0045	0.0039	0.0051	0.0075	0.0099	0.0096	0.0154	0.0254	

Percent by weight finer than sieve size (mm) indicated

0.06	0.4	0.5	0.7	0.4	0.3	0.5	0.4	0.9	0.7	0.5	0.4	0.6	0.4	0.4
.09	.5	.7	.8	.7	.6	.5	.4	.9	.7	.5	.4	.8	.5	.6
.12	.6	.8	1.0	.8	.8	.9	.8	1.4	1.1	.7	.7	1.0	.7	.8
.18	.9	1.2	1.5	1.2	1.1	1.4	1.2	2.3	1.8	1.2	.9	1.5	1.1	1.2
.25	2.2	4.2	4.9	4.8	5.8	9.0	7.8	11.1	11.5	5.8	6.5	6.1	4.5	4.0
.35	8.4	22.2	24.4	19.7	23.8	30.8	29.4	33.3	30.9	20.8	27.1	21.0	16.5	17.0
.50	17.3	42.4	42.3	33.1	39.1	47.1	49.8	48.6	43.5	34.6	45.9	32.1	26.9	33.5
.71	29.2	61.5	58.8	50.7	53.7	58.4	67.3	60.6	52.2	46.0	59.2	42.2	35.8	46.2
1.00	39.1	78.5	74.3	67.4	65.8	68.3	77.1	68.5	59.4	56.7	68.5	52.7	47.0	55.1
1.41	50.8	88.9	86.1	81.2	78.3	74.7	84.5	74.5	66.5	70.7	76.0	64.7	61.0	65.1
2.00	65.5	94.2	93.5	90.2	89.1	80.1	90.2	80.1	74.1	86.4	83.9	77.1	76.2	77.7
2.83	78.7	96.7	97.1	94.4	95.0	84.6	93.9	85.2	82.4	95.4	92.3	87.0	88.2	88.8
4.00	89.1	98.4	99.0	96.9	97.8	89.6	96.3	89.4	89.2	98.8	96.1	92.4	95.5	95.4
5.66	95.1	99.1	99.5	98.3	99.0	92.8	97.6	92.6	93.2	99.5	98.2	94.8	99.1	98.8
8.00	98.1	99.3	100.0	99.6	100.0	97.3	100.0	97.7	97.5	100.0	99.4	97.5	100.0	99.8
11.3	99.3	99.7	-----	100.0	-----	98.6	-----	100.0	100.0	-----	100.0	98.7	-----	100.0
16.0	100.0	100.0	-----	-----	-----	100.0	-----	-----	-----	-----	-----	100.0	-----	-----
22.6	-----	-----	-----	-----	-----	-----	-----	-----	-----	-----	-----	-----	-----	-----
32.0	-----	-----	-----	-----	-----	-----	-----	-----	-----	-----	-----	-----	-----	-----
5.0	-----	-----	-----	-----	-----	-----	-----	-----	-----	-----	-----	-----	-----	-----
64.0	-----	-----	-----	-----	-----	-----	-----	-----	-----	-----	-----	-----	-----	-----

Particle size (mm) at given percent finer

d ₅	0.31	0.26	0.25	0.25	0.24	0.22	0.23	0.21	0.21	0.24	0.24	0.24	0.26	0.26
d ₁₆	.48	.33	.32	.33	.31	.29	.30	.28	.28	.32	.30	.32	.35	.35
d ₃₅	.87	.45	.44	.52	.46	.39	.39	.37	.40	.51	.41	.55	.69	.52
d ₅₀	1.38	.57	.59	.70	.65	.55	.50	.52	.65	.81	.56	.92	1.08	.82
d ₆₅	1.98	.75	.81	.95	.98	.89	.67	.85	1.31	1.22	.87	1.43	1.54	1.41
d ₈₄	3.33	1.18	1.32	1.56	1.67	2.72	1.39	2.62	3.06	1.88	2.02	2.52	2.47	2.40
d ₉₅	5.61	2.20	2.25	3.03	2.83	6.49	3.26	6.41	6.34	2.76	3.55	5.77	3.86	3.88

Date ¹	6-24-75	6-25-75	6-25-75	6-25-75	6-25-75	6-26-75	6-26-75	6-26-75	6-26-75	5-28-76	5-28-76	5-29-76	5-29-76
Q ²	10.9	20.3	20.4	21.9	21.9	15.1	14.9	11.3	11.1	20.1	19.9	21.0	21.0
k ³	0.0183	0.0926	0.0814	0.0912	0.0725	0.0684	0.0976	0.0513	0.0683	0.0390	0.0822	0.1205	0.0977

Percent by weight finer than sieve size (mm) indicated

0.06	0.5	0.4	0.3	0.4	0.4	0.4	0.4	0.3	0.1	0.4	0.2	0.3	0.4
.09	.7	.4	.4	.5	.5	.5	.5	.4	.2	.6	.3	.4	.5
.12	.9	.6	.6	.7	.6	.7	.6	.4	.3	.9	.5	.5	.8
.18	1.4	1.0	1.0	1.1	.9	1.0	.9	.7	.5	1.5	.8	.8	1.2
.25	4.9	3.1	3.0	3.2	2.7	2.8	2.4	1.8	1.0	8.7	3.7	3.0	4.9
.35	18.5	12.3	11.4	9.3	7.8	9.6	9.0	5.6	2.9	25.8	14.4	10.2	19.7
.50	34.7	28.8	26.2	19.1	15.3	22.8	22.8	15.3	9.4	41.9	35.1	22.0	42.9
.71	47.3	43.6	40.2	31.1	23.8	41.3	45.1	31.9	24.5	52.6	55.5	35.2	63.5
1.00	57.5	53.8	50.4	43.0	34.9	61.8	68.2	48.3	48.4	58.5	66.3	45.6	73.6
1.41	67.0	64.5	61.1	56.9	46.6	77.1	82.4	64.1	69.4	63.4	74.9	57.3	80.9
2.00	78.3	77.0	71.9	71.6	58.8	88.1	90.8	78.5	84.3	68.0	83.1	71.2	86.9
2.83	89.6	87.0	80.3	82.0	70.1	94.9	95.5	89.0	93.0	72.0	89.5	83.6	91.5
4.00	96.0	93.7	88.5	89.3	79.9	98.5	98.2	95.2	97.8	75.5	93.6	91.5	94.9
5.66	98.4	97.3	91.6	93.7	89.9	99.5	99.4	98.3	99.1	79.6	96.3	96.5	97.5
8.00	99.5	99.1	97.3	96.5	95.6	99.8	99.8	99.7	99.8	82.7	97.9	98.8	99.2
11.3	100.0	99.7	99.4	97.8	98.3	100.0	99.8	100.0	100.0	84.9	98.5	100.0	99.7
16.0	-----	100.0	100.0	98.8	99.3	-----	99.8	-----	-----	90.4	98.9	-----	99.8
22.6	-----	-----	-----	98.8	100.0	-----	100.0	-----	-----	92.6	99.4	-----	100.0
32.0	-----	-----	-----	98.8	-----	-----	-----	-----	-----	100.0	100.0	-----	-----
45.0	-----	-----	-----	100.0	-----	-----	-----	-----	-----	-----	-----	-----	-----
64.0	-----	-----	-----	-----	-----	-----	-----	-----	-----	-----	-----	-----	-----

Particle size (mm) at given percent finer

d ₅	0.25	0.28	0.28	0.29	0.30	0.29	0.30	0.34	0.41	0.22	0.28	0.29	0.25
d ₁₆	.34	.39	.40	.45	.51	.43	.43	.51	.60	.30	.37	.43	.33
d ₃₅	.50	.58	.63	.80	1.00	.63	.61	.76	.83	.43	.50	.70	.45
d ₅₀	.78	.88	.99	1.19	1.56	.82	.76	1.04	1.03	.65	.64	1.14	.56
d ₆₅	1.31	1.43	1.60	1.70	2.41	1.07	.95	1.44	1.31	1.59	.96	1.70	.74
d ₈₄	2.34	2.53	3.28	3.09	4.55	1.73	1.50	2.36	1.99	10.0	2.10	2.89	1.69
d ₉₅	3.71	4.42	6.69	6.51	7.61	2.85	2.70	3.94	3.15	23.6	4.67	4.95	4.03

¹Dates correspond to dates listed in table 6.²Discharge over 14.6-m width of bedload trap; includes all flow over the active width of the streambed.³Unit transport rate of solids in dry weight per second, over 14.6-m width of bedload trap.

TABLE 8.—Summary of statistical data: log-transformed linear regression of transport rate by particle-size class versus total transport rate, conveyor-belt sampler¹

Particle-size class (mm)	Number of data points	j_b (size class) = $A j_b$ (total) ^B [$Y = AX^B$]					Correlation coefficient, r	\bar{Y}/\bar{X} (percent)
		\bar{Y} (kg/m-s)	\bar{X} (kg/m-s)	A	B			
0.06- 0.12	--86	0.000092	0.029164	0.000961	0.663	0.912	0.32	
.12- .25	--88	.000520	.029855	.003627	.553	.890	1.74	
.25- .50	--88	.005519	.029855	.074800	.742	.954	18.49	
.50- 1.00	--88	.008326	.029855	.278676	1.000	.994	27.89	
1.00- 2.00	--88	.006535	.029855	.401883	1.173	.992	21.89	
2.00- 4.00	--88	.004139	.029855	.368044	1.278	.985	13.87	
4.00- 8.00	--88	.001659	.029855	.116466	1.211	.957	5.56	
8.00- 16.0	--86	.000460	.030946	.014618	.995	.808	1.49	
16.0- 32.0	--43	.000379	.049484	.006132	.926	.875	.77	
32.0- 64.0	---6	.000800	.107516	.653752	3.007	.760	.74	

¹Basic data as collected.

TABLE 9.—Summary of statistical data: log-transformed linear regression of transport rate by particle-size class versus total transport rate, Helley-Smith sampler¹

Particle-size class (mm)	Number of data points	j_b (size class) = $A j_b$ (total) ^B [$Y = AX^B$]					Correlation coefficient, r	\bar{Y}/\bar{X} (percent)
		\bar{Y} (kg/m-s)	\bar{X} (kg/m-s)	A	B			
0.06- 0.12	--82	0.000116	0.032706	0.001390	0.727	0.913	0.35	
.12- .25	--83	.001027	.031693	.008111	.599	.858	3.24	
.25- .50	--83	.007254	.031693	.080705	.698	.912	22.89	
.50- 1.00	--83	.008510	.031693	.319448	1.050	.978	26.84	
1.00- 2.00	--83	.006360	.031693	.419373	1.213	.973	20.07	
2.00- 4.00	--83	.003362	.031693	.348418	1.344	.939	10.61	
4.00- 8.00	--80	.001185	.034352	.066206	1.193	.870	3.45	
8.00- 16.0	--68	.000356	.039981	.005802	.867	.714	.89	
16.0- 32.0	--18	.000421	.065133	.001210	.387	.385	.65	

¹Basic data as collected.

TABLE 10.—Listing of comparable data sets used in direct comparison of results from conveyor-belt sampler with results from Helley-Smith sampler

Date	Effective discharge, ¹ Q' (m ³ /s)		Discharge ratio squared, ² $\left(\frac{Q'_{cb}}{Q'_{H}}\right)^2$	Unit bedload transport rate, ³ j_b (kg/m-s)			
	Conveyor belt	Helley-Smith		Conveyor belt		Helley-Smith	
				(⁴)	(⁵)	(⁴)	(⁶)
6-01-73	16.1	15.8	1.04	0.0190	0.0190	0.0065	0.0067
6-02-73	17.8	17.5	1.03	.0235	.0235	.0277	.0287
6-03-73	16.6	17.0	.95	.0240	.0240	.0425	.0405
6-06-73	11.3	11.4	.98	.0133	.0133	.0074	.0073
6-07-73	15.9	15.6	1.04	.0260	.0260	.0383	.0398
6-08-73	19.2	18.6	1.07	.0218	.0218	.0059	.0063
5-25-74	5.34	5.34	1.00	.0056	.0056	.0046	.0046
5-26-74	9.92	10.4	.91	.0822	.0632	.0451	.0410
5-26-74	9.92	9.73	1.04	.0822	.0632	.0583	.0606
5-27-74	21.5	21.9	.96	.1758	.1352	.1702	.1640
5-28-74	29.8	27.7	1.16	.2255	.1735	.1532	.1773
5-28-74	29.8	30.3	.97	.2255	.1735	.2533	.2450
5-29-74	41.5	41.8	.99	.2912	.2240	.3025	.2982
5-30-74	32.2	33.8	.91	.0786	.0605	.1227	.1114
5-31-74	22.9	23.5	.95	.0647	.0498	.0768	.0729
6-01-74	24.3	24.2	1.01	.0206	.0206	.0200	.0202
6-02-74	25.5	25.7	.98	.0130	.0130	.0106	.0104
6-03-74	29.7	29.7	1.00	.0172	.0172	.0233	.0233
6-04-74	27.9	28.0	.99	.0285	.0285	.0307	.0305
6-05-74	26.5	26.4	1.01	.0305	.0305	.0447	.0450
5-27-75	2.44	2.44	1.00	.0021	.0021	.0034	.0034
5-27-75	2.44	2.44	1.00	.0021	.0021	.0062	.0062
6-02-75	5.82	5.28	1.22	.0484	.0372	.0649	.0789
6-02-75	5.82	5.25	1.23	.0484	.0372	.0749	.0920
6-03-75	9.13	8.75	1.09	.0791	.0608	.0093	.0101

SEDIMENT-TRAPPING CHARACTERISTICS OF THE HELLEY-SMITH BEDLOAD SAMPLER

TABLE 10.—Listing of comparable data sets used in direct comparison of results from conveyor-belt sampler with results from Helley-Smith sampler—Continued

Date	Effective discharge, ¹ Q' (m ³ /s)		Discharge ratio squared, ² $\left(\frac{Q'_{cb}}{Q'_{HS}}\right)^2$	Unit bedload transport rate, ³ \dot{b} (kg/m-s)			
	Conveyor belt	Helley- Smith		Conveyor belt		Helley-Smith	
				(⁴)	(⁵)	(⁴)	(⁶)
6-04-75	10.0	9.73	1.06	.0812	.0625	.0983	.1038
6-05-75	10.7	10.2	1.10	.0972	.0748	.0512	.0563
6-05-75	10.7	10.1	1.12	.0972	.0748	.0829	.0930
6-06-75	20.0	19.7	1.03	.3114	.2395	.1076	.1109
6-06-75	20.0	20.1	.99	.3114	.2395	.0860	.0851
6-07-75	24.8	25.2	.97	.2069	.1592	.1262	.1222
6-07-75	24.8	25.3	.96	.2069	.1592	.0474	.0455
6-07-75	24.8	24.9	.99	.2069	.1592	.2168	.2151
6-07-75	24.8	24.7	1.01	.2069	.1592	.1896	.1911
6-08-75	25.6	25.6	1.00	.1733	.1333	.2027	.2027
6-08-75	25.6	25.7	.99	.1733	.1333	.1025	.1017
6-09-75	24.3	25.4	.92	.0838	.0722	.1185	.1085
6-09-75	24.3	25.4	.92	.0838	.0722	.1054	.0965
6-10-75	14.4	16.1	.80	.0348	.0268	.0674	.0539
6-10-75	14.4	15.9	.82	.0348	.0268	.0298	.0244
6-11-75	10.1	10.5	.93	.0110	.0110	.0210	.0194
6-11-75	10.1	10.4	.94	.0110	.0110	.0225	.0212
6-13-75	15.8	15.9	.99	.0277	.0213	.0337	.0333
6-13-75	15.8	15.9	.99	.0277	.0213	.0252	.0249
6-17-75	22.2	23.0	.93	.0796	.0612	.0879	.0819
6-17-75	22.2	23.0	.93	.0796	.0612	.1052	.0980
6-18-75	12.8	13.1	.95	.0106	.0106	.0265	.0253
6-18-75	12.8	13.1	.95	.0106	.0106	.0195	.0186
6-19-75	10.1	10.5	.93	.0097	.0097	.0163	.0151
6-19-75	10.1	10.5	.93	.0097	.0097	.0114	.0106
6-21-75	7.23	7.48	.93	.0032	.0032	.0039	.0036
6-21-75	7.23	7.48	.93	.0032	.0032	.0051	.0048
6-22-75	7.01	7.27	.93	.0047	.0047	.0075	.0070
6-22-75	7.01	7.27	.93	.0047	.0047	.0099	.0092
6-23-75	8.24	8.17	1.02	.0062	.0062	.0096	.0098
6-23-75	8.24	8.17	1.02	.0062	.0062	.0154	.0157
6-24-75	10.8	10.9	.98	.0194	.0194	.0254	.0249
6-24-75	10.8	10.9	.98	.0194	.0194	.0183	.0180
6-25-75	21.7	20.3	1.14	.0838	.0645	.0926	.1058
6-25-75	21.7	20.4	1.13	.0838	.0645	.0814	.0921
6-25-75	21.7	21.9	.98	.0838	.0645	.0912	.0895
6-25-75	21.7	21.9	.98	.0838	.0645	.0725	.0712
6-26-75	13.1	15.1	.75	.0396	.0396	.0684	.0515
6-26-75	13.1	14.9	.77	.0396	.0396	.0976	.0754
6-26-75	13.1	11.3	1.34	.0396	.0396	.0513	.0689
6-26-75	13.1	11.1	1.39	.0396	.0396	.0683	.0951
5-28-76	18.8	20.1	.87	.0437	.0336	.0390	.0341
5-28-76	18.8	19.9	.89	.0437	.0336	.0822	.0734
5-28-76	19.8	20.1	.97	.0454	.0454	.0390	.0378
5-28-76	19.8	19.9	.99	.0454	.0454	.0822	.0814
5-29-76	20.5	21.0	.95	.0712	.0548	.1205	.1148
5-29-76	20.5	21.0	.95	.0712	.0548	.0977	.0931
5-29-76	20.9	21.0	.99	.0618	.0618	.1205	.1194
5-29-76	20.9	21.0	.99	.0618	.0618	.0977	.0968

¹Discharge over 14.6-m width of bedload trap; includes all flow over the active width of the streambed.

²Regression of transport data from table 4 indicates the transport rate is proportional to the square of the effective discharge. To correct for stage (discharge) differences between otherwise comparable conveyor-belt and Helley-Smith data sets, the appropriate correction applied to Helley-Smith transport data is the factor $(Q'_{cb}/Q'_{HS})^2$.

³Unit transport rate of solids in dry weight per second, over 14.6-m width of bedload trap.

⁴Basic data as collected.

⁵Conveyor-belt data corrected to conditions of stream-wide slot.

⁶Helley-Smith data corrected for stage difference with conveyor-belt data; see note 2.

TABLE 11.—Summary of statistical data: log-transformed linear regression of transport rate, Helley-Smith sampler versus conveyor-belt sampler (basic data)

Particle-size class (mm)	Number of data points	j_b (Helley-Smith) = $A j_b$ (conveyor-belt) [#] [Y = AX [#]]									
		Log Y	Log X	SD (log Y)	SD (log X)	Log A	B	r ²	Var (log (A))	SE (log (A))	Var (B)
0.06- 0.12	61	-3.713838	-3.804032	0.430278	0.389728	-0.1841	0.928	0.7394	0.078713	0.280558	0.005384
.12- .25	61	-2.821671	-3.147199	.280158	.299980	- .4586	.751	.6463	.052254	.228591	.005229
.25- .50	61	-1.961669	-2.137697	.342941	.361216	- .2473	.802	.7135	.020564	.143400	.004377
.50- 1.00	61	-1.882042	-1.876378	.540334	.509253	- .1289	.934	.7755	.016175	.127180	.004284
1.00- 2.00	61	-1.975948	-1.927100	.584104	.584409	- .3024	.868	.7550	.016799	.129610	.014148
2.00- 4.00	61	-2.189868	-2.126512	.584247	.623490	- .4831	.803	.7336	.019445	.139445	.003965
4.00- 8.00	61	-2.668660	-2.640915	.589985	.682776	- .7161	.739	.7331	.025106	.158450	.003378
8.00-16.0	53	-3.248296	-3.219476	.632180	.761091	- .8438	.747	.8085	.028324	.168298	.002591
16.0-32.0	14	-3.330789	-3.076402	.481029	.458405	- 1.7910	.501	.2275	.684715	.827475	.070886

Particle-size class (mm)	Number of data points	j_b (Helley-Smith) = $A j_b$ (conveyor-belt) [#] [Y = AX [#]]						
		\bar{Y} (kg/m-s)	\bar{X} (kg/m-s)	$\bar{Y/X}$ (percent)	A	SE (A)	B	SE (B)
0.06- 0.12	61	0.000193	0.000157	123.08	0.654	1.91	0.928	0.073
.12- .25	61	.001508	.000713	211.66	.348	1.70	.751	.072
.25- .50	61	.010923	.007283	149.98	.566	1.39	.802	.066
.50- 1.00	61	.013121	.013293	98.70	.743	1.34	.934	.065
1.00- 2.00	61	.010569	.011828	89.36	.498	1.35	.868	.064
2.00- 4.00	61	.006459	.007473	89.43	.329	1.38	.803	.070
4.00- 8.00	61	.002145	.002286	93.81	.192	1.44	.739	.058
8.00-16.0	53	.000565	.000603	93.58	.143	1.47	.747	.051
16.0-32.0	14	.000467	.000839	55.67	.016	8.54	.501	.266

TABLE 12.—Summary of statistical data: log-transformed linear regression of transport rate, Helley-Smith sampler versus conveyor-belt sampler (comparison of various modifications to the basic data)¹

Conditions applied to the regression statistics (see notes)	Number of data points	j_b (Helley-Smith) = $A j_b$ (conveyor-belt) [#] [Y = AX [#]]					
		\bar{Y} (kg/m-s)	\bar{X} (kg/m-s)	A	B	Correlation coefficient, r	$\bar{Y/X}$ (percent)
(²)	74	0.041516	0.038041	0.550	0.790	0.881	109.14
(² , ³)	74	.041516	.038041	1.150	1.013	.881	109.14
(⁴)	74	.041516	.033349	.762	.856	.881	124.49
(³ , ⁴)	74	.041516	.033349	1.594	1.102	.881	124.49
(⁴ , ⁵)	74	.041023	.033349	.784	.867	.887	123.01
(⁴ , ⁵ , ⁶)	74	.041023	.033349	.960	.927	-----	123.01
(⁴ , ⁷)	61	.048285	.039375	.846	.885	.906	122.63
(⁴ , ⁸)	61	.034967	.032015	.819	.916	.891	109.22
(⁴ , ⁶ , ⁸)	61	.034967	.032015	1.016	.979	-----	109.22
(⁴ , ⁵ , ⁷)	61	.048045	.039375	.873	.896	.908	122.02
(⁴ , ⁵ , ⁸)	61	.034763	.032015	.843	.927	.893	108.58
(⁴ , ⁵ , ⁶ , ⁸)	61	.034763	.032015	1.053	.991	-----	108.58

¹Total bedload.
²Basic data as collected.
³Regression treats Helley-Smith data as independent variable.
⁴Conveyor-belt data corrected to conditions of stream-wide slot.
⁵Helley-Smith data corrected for stage difference with conveyor-belt data.
⁶Includes correction for variance of independent variable in least-squares regression.
⁷Excludes sediment particles smaller than 0.25 mm.
⁸Excludes sediment particles smaller than 0.50 mm.

SEDIMENT-TRAPPING CHARACTERISTICS OF THE HELLEY-SMITH BEDLOAD SAMPLER

TABLE 13.—Summary of statistical data: log-transformed linear regression of transport rate, Helley-Smith sampler versus conveyor-belt sampler (conveyor-belt data corrected for conditions of stream-wide slot)

Particle-size class (mm)	Number of data points	j_b (Helley-Smith) = $A j_b$ (conveyor-belt) [#] [$Y = AX^B$]									
		$\overline{\text{Log } Y}$	$\overline{\text{Log } X}$	$SD(\text{log } Y)$	$SD(\text{log } X)$	$\text{Log } A$	B	r^2	Var (log(A))	SE (log(A))	Var (B)
0.06- 0.12	61	-3.713838	-3.869253	0.430278	0.356737	0.2701	1.030	0.7287	0.100988	0.317786	0.006690
12- .25	61	-2.821671	-3.212598	.280158	.258133	-.0341	.868	.6392	.074816	.273525	.007203
.25- .50	61	-1.961669	-2.263078	.342941	.319925	.0527	.914	.7275	.025758	.160494	.005307
.50- 1.00	61	-1.882042	-1.941755	.540334	.468626	.0899	1.016	.7758	.020139	.141912	.005052
1.00- 2.00	61	-1.975948	-1.992475	.584104	.545829	-.1372	.923	.7437	.021207	.145626	.004975
2.00- 4.00	61	-2.189868	-2.191892	.584247	.584976	-.3323	.848	.7200	.025468	.189586	.004734
4.00- 8.00	61	-2.669660	-2.706331	.589595	.645916	-.5720	.775	.7204	.030541	.174759	.003949
8.00-16.0	53	-3.248296	-3.285883	.632180	.722824	-.6607	.788	.8107	.032110	.179194	.002839
16.0-32.0	14	-3.330789	-3.190414	.481029	.458413	-1.7338	.501	.2275	.735338	.857518	.070884

Particle-size class (mm)	Number of data Points	j_b (Helley-Smith) = $A j_b$ (conveyor-belt) [#] [$Y = AX^B$]						
		\overline{Y} (kg/m-s)	\overline{X} (kg/m-s)	$\overline{Y/X}$ (percent)	A	SE (A)	B	SE (B)
0.06- 0.12	61	0.000193	0.000135	143.03	1.863	2.08	1.030	0.082
12- .25	61	.001508	.000613	246.00	.924	1.88	.868	.085
.25- .50	61	.010923	.006265	174.34	1.129	1.45	.914	.073
.50- 1.00	61	.013121	.011435	114.74	1.230	1.39	1.016	.071
1.00- 2.00	61	.010569	.010175	103.88	.729	1.40	.923	.071
2.00- 4.00	61	.006459	.006428	100.47	.465	1.44	.848	.069
4.00- 8.00	61	.002145	.001966	109.06	.268	1.50	.775	.063
8.00-16.0	53	.000565	.000518	109.04	.218	1.51	.788	.053
16.0-32.0	14	.000467	.000645	72.38	.018	7.20	.501	.266

